

Manual

Starflow QSD Model 6527B and 6537A

This equipment has been tested and found to comply with the limits for a Class A digital device, pursuant to Part 15 of the FCC Rules in the USA. These limits are designed to provide reasonable protection against harmful interference when the equipment is operated in a commercial environment. This equipment generates, uses, and can radiate radio frequency energy and, if not installed and used in accordance with the instruction manual, may cause harmful interference to radio communications. Operation of this equipment in a residential area is likely to cause harmful interference, in which case the user will be required to correct the interference at their own expense.

This equipment has been tested for compliance with European regulations as follows:

Application of Council Directive:
2004/108/EC

Standards to which Conformity is declared:

EN-61000-6-1:2001
EN-61000-4-2:1995
EN-61000-4-3:1995
EN-61000-4-4:1995
EN-61000-4-6:1996
ENV-50204:1995

Any changes or modifications to this equipment not expressly approved by the manufacturer Unidata Pty Ltd could void the user's authority to operate this equipment.



Revision History

File name / Revision	Date	Authors & Change Details	Checked/ Approved
Unidata Manual - 6537A Starflow QSD SDI-12 User Manual 27 05 2019.docx	27 05 19	IM First Draft	MS
Unidata Manual - 6537A Starflow QSD User Manual 21 06 2019	21 06 19	RDS, PD	MS
Unidata Manual - 6537A Starflow QSD User Manual 04 07 2019.doc	04 07 19	CB	KC
Unidata Manual - 6537A Starflow QSD User Manual 12 07 2019.doc	12 07 19	KC	MS
Unidata Manual - 6537A Starflow QSD User Manual 17 07 2019	17 07 19	KC MS	MS
Unidata Manual - 6537A Starflow QSD User Manual 28 10 2019.doc	28 10 19	CB	PD
Unidata Manual - 6527B and 6537A Starflow QSD User Manual 27 11 2019.doc	27 11 19	IM	CB
Unidata Manual - 6527B and 6537A Starflow QSD User Manual 17 01 2020.docx	17 01 20	IM Update EC Specs	DM
Unidata Manual - 6527B and 6537A Starflow QSD User Manual 30 03 2020.docx	30 03 20	PD, RDS	CB
Unidata Manual - 6527B and 6537A Starflow QSD User Manual 18 09 2020.docx	18 09 20	CB	IM
Unidata Manual - 6527B and 6537A Starflow QSD User Manual 21 10 2022.docx	21 10 22	CB Update SDI12/Modbus Specs	IM
Unidata Manual - 6527B and 6537A Starflow QSD User Manual 08 05 2023.docx	08 05 23	CB Add logger functionality	KC

Copyright © Unidata Pty Ltd 2000-2020. All rights reserved. No part of this publication may be reproduced, transmitted, transcribed, stored in a retrieval system, or translated into any spoken or computer language, in any form or by any means. Electronic, mechanical, magnetic, optical, chemical, manual, or otherwise, without prior written permission of Unidata Pty Ltd 40 Ladner St, O'Connor Western Australia 6163.

TABLE OF CONTENTS

Starflow QSD Model 6527B and 6537A 1

1. Operation Mode 6

1.1. Operation Mode Configuring using SDI-12 protocol..... 6

1.2. Operation Mode Configuring using Modbus RTU protocol..... 6

2. Introduction 7

3. Specifications 9

3.1. Velocity (Continuous Beam) 9

3.2. Depth (Ultrasonic)..... 9

3.3. Depth (Pressure)..... 9

3.4. Temperature 9

3.5. Electrical Conductivity (EC) – 6537A ONLY 9

3.6. Tilt (accelerometer)..... 10

3.7. Power Requirements 10

3.8. Communications 10

3.9. Environmental 10

3.10. Physical..... 10

3.11. Instrument Wiring Table..... 11

4. Operating Principles & Measured Parameters 13

4.1 Flow Velocity Measurement..... 13

4.2 Water Depth Measurement – Ultrasonic..... 14

4.3 Water Depth Measurement - Pressure 14

4.4 Temperature 15

4.5 Electrical Conductivity EC 6537A Only 15

4.6 Accelerometer..... 15

4.7 Power Supply Voltage..... 15

4.8 Signal Spread 16

4.9 Received Signal Strength Indicator (RSSI)..... 16

5. Taking Measurements From Instrument..... 17

5.1. SDI-12 Operation 17

5.1.1. Channels Table 18

5.1.2. Measurement Command (aM!) 18

5.1.3. Additional SDI-12 Commands 20

5.1.4. Unidata Logger SDI-12 Scheme Setup 22

5.2. Modbus RS485 Operation 27

5.2.1. Reading the measured parameters via Modbus 27

5.2.2. Master Format 27

5.2.3. Slave Response Format 28

5.2.4. Standard Message Format 28

5.2.5. Modbus Registers 29



- 5.2.6. Additional Modbus Commands 30
- 5.2.7. Unidata Logger Modbus Scheme Setup 32
- 6. Installation38**
 - 6.1. Site Considerations..... 38
 - 6.2. Instrument Mounting – Pipes & Culverts 39
 - 6.3. Instrument Mounting – Open Channels 41
- 7. Instrument Maintenance.....43**
- 8. Factors Affecting Flow Measurement Accuracy44**
 - 8.1. Alignment with Flow and Depth 44
 - 8.2. Instantaneous Versus “Averaged” Velocity 44
 - 8.3. Conversion of Logged to Mean Velocity..... 45
 - 8.4. The Speed of Sound in Water 45
- Starflow QSD Model 6527L47**
- 9. Starlog V4 Starflow QSD Instrument-Only Software Installation47**
- 10. Starflow QSD Scheme Management55**
 - 10.1. Scheme Editor 55
 - 10.2. Settings 57
 - 10.3. Instruments 58
 - 10.4. Flow Measurement Extension 60
 - 10.5. Overview of Creating a Flow Scheme 61
 - 10.5.1. Creating an Area Rating Table 63
 - 10.5.2. Partially Filled Pipe 63
 - 10.5.3. Open Channel and Natural Stream 66
 - 10.6. Other Applications..... 70
- 11. Configuring Starflow QSD.....71**
 - 11.1. Configuring the Starflow QSD as an SDI-12 Sensor 72
 - 11.2. Configuring the Starflow QSD for Modbus RTU 74
 - 11.3. Configuring Starflow QSD Settings..... 79
 - 11.3.1. Log Buffer 83
 - 11.3.2. Instrument Channels 83
 - 11.3.3. Log Intervals 84
 - 11.3.4. Saving the Scheme 85
- 12. Programming Starflow QSD.....87**
- 13. Test Mode88**
 - 13.1. Scheme Channels..... 89
- 14. Unloading Data from Loggers.....90**
- 15. Viewing Data.....93**
 - 15.1. Starlog V4 (*.CSV) Files 93
 - 15.2. Viewing the Data File 93
 - 15.2.1. Graph View 94
 - 15.2.2. Table View 94

15.2.3.	Opening with Notepad	95
15.2.4.	Opening with Excel	95
16.	Power Failure.....	97
17.	Diagnostics.....	98
17.1.	Velocity Trace	98
17.2.	Velocity Histograms	99
17.3.	Inherent Factors in Doppler Histograms	100
17.4.	Varying Angles as Particles Pass through the Main Beam	100
17.5.	Measuring Errors Due To “Signal Noise”	101
17.6.	Channel Characteristics Affecting the Signal	101
17.7.	The Nature and Location of the “Reflectors” in the Water	102
17.8.	Velocity Variations Due to Cross-Section Changes	103
17.9.	Measuring Unexpected Velocities	104
17.10.	Measuring Turbulent Velocities	105
17.11.	Effects of Surface Ripples	106
17.12.	Measuring Flows in Very Small Channels	107
17.13.	Velocities Too Slow to Measure	107
17.14.	Measuring Velocities in Very Shallow Water	108
17.15.	Interference to the Transducers.....	108
17.15.1.	Silt, Algae and Other Soft, Saturated Materials	108
17.15.2.	Burying the Transducer in Sand	109
17.16.	Initialise	111
17.17.	Configure	111
17.18.	Upgrade Firmware	112

1. OPERATION MODE

There are two modes of operation for the Starflow QSD, SDI-12 and Modbus RTU. SDI-12 operates so that when a Measurement command is sent, the Starflow QSD will initiate a read at this time and then provide data after 5 seconds. This allows for power saving as the rest of the time, the unit is in a sleeping state. When the Unit is in Modbus RTU mode, measurements are updated every 5 seconds, therefore, consuming more power. This is required when measurements are required at faster rates. To set the Starflow QSD to either SDI-12 mode (0) or Modbus mode (5).

1.1. Operation Mode Configuring using SDI-12 protocol

0 = SDI-12

* NOTE 5 = 5 second Modbus scan update or as per how often the Modbus registers are required to update (5 is the minimum value)

To view the mode of operation, use the following SDI-12 commands.

Example 1 Examine:

Send – 0X8! <CR><LF>

Response – 0+0<CR><LF> (This shows the instrument is in SDI-12 mode).

Example 2 Change:

Send – 0X8+5! <CR><LF>

Response - 0+5<CR><LF> (This changes QSD from SDI-12 mode to Modbus mode)

1.2. Operation Mode Configuring using Modbus RTU protocol

0 = SDI-12

* NOTE 5 = 5 second Modbus scan update or as per how often the Modbus registers are required to update (5 is the minimum value)

Example: Set Modbus 5 second update (default):

Send - 01 06 00 64 00 05 08 16

Receive - 01 06 00 64 00 05 08 16

2. INTRODUCTION

The 1st generation 6527 Starflow QSD Instrument measures water velocity, depth (ultrasonic) and temperature. The Starflow QSD – 2nd generation has been enhanced to include depth measurement using the hydrostatic pressure method (6527B Starflow QSD), electrical conductivity (6537A Starflow QSD), and a tilt sensor that is useful for installation and site monitoring. These models come standard with both SDI-12 and RS-485 (Modbus RTU) interfaces.

The capacity of the instrument to measure the water conductivity is unique. It allows the instrument to determine not only the water velocity, flow, and volume but also an indication of the water quality. The conductivity measurement can also be used where existing techniques for measuring water quality are unsuitable or too expensive. By using Digital Signal Processing (DSP) techniques, the Starflow QSD can perform in a wide range of environments. It is used to measure flows and water conductivity (6537A) in pipes, channels, and small streams. It can operate in a range of water qualities, from fresh streams to primary sewage channels.

The electrical conductivity feature of the 6537A instrument empowers the user to detect unusual waste dumping/agriculture runoff that is not visible using current flow sensors. The pressure depth sensor allows the instrument to be placed in an angled position on the wall of irregularly shaped drainage canals or on the sides of channels in which it is difficult or impossible to place the instrument on the channel floor.

The tilt parameter is measured by an internal accelerometer. It represents the pitch and roll of the instrument's body as it is installed, and its value is expressed in degrees of angle. This provides the user with useful information about the sensor after being mounted underwater or during a post-installation inspection.

Starflow QSD system consists of the following:

Model 6527B or 6537A Starflow QSD instrument
Model 6527M Stainless Steel Mounting Bracket

6527B



6537A



Hardware Accessories:

The following accessories should be purchased according to your application requirements.

- Model 6907B-14 12V, 14Ah Sealed Lead Acid Battery
- Model 6904I-10 10W Solar Recharge Panel & Mount
- Model 6904I-20 20W Solar Recharge Panel & Mount
- Model 6702S Starflow QSD Weatherproof Enclosure
- Model 6705A Small Expanding Clamp SS expanding turnbuckle and band clips.
100mm wide, 100mm long, 50mm expansion
Use in pipes up to 600mm (24") in diameter.
- Model 6705B Large Expanding Clamp SS expanding turnbuckle and band clips.
100mm wide, 150mm long, 100mm expansion
Use in pipes over 600mm (24") in diameter.
- Model 6705D 1800mm Band Segment 100mm wide, 0.6mm Stainless Steel band
With 50mm spaced locating holes at both ends
- Model 6705F Band Joiner Stainless Steel joiner

Instrument Accessories:

Model 6515 QSD Barometric Reference for pressure depth reading compensation.

3. SPECIFICATIONS

3.1. Velocity (Continuous Beam)

Range	20mm/sec to 0.8 m/sec 20mm/sec to 1.6 m/sec (default) 20mm/sec to 3.2 m/sec 20mm/sec to 6.6 m/sec
Accuracy	Bidirectional velocity capability, set using configuration tools Typical $\pm 1\%$
Resolution	1 mm/s

3.2. Depth (Ultrasonic)

Range	20mm to 5000mm (5m)
Accuracy	$\pm 1\%$ of the full scale
Resolution	1 mm

3.3. Depth (Pressure)

Range	0mm to 10m
Accuracy	Typical $\pm 0.19\%$ for 0m to 5m range Typical $\pm 0.38\%$ for 0m to 10m range
Resolution	1 mm

3.4. Temperature

Range	0°C to 60°C
Accuracy	$\pm 0.5^\circ\text{C}$
Resolution	0.1°C

3.5. Electrical Conductivity (EC) – 6537A ONLY

Range	0 to 200,000 $\mu\text{S/cm}$, typically $\pm 1\%$ of the measurement
Resolution	$\pm 1 \mu\text{S/cm}$
	It may be recorded as a 16-bit value (0 to 65,535 $\mu\text{S/cm}$) or a 32-bit value (0 to 262,143 $\mu\text{S/cm}$)

3.6. Tilt (accelerometer)

Range	±70° in roll and pitch axes.
Accuracy	±1° for angles less than 45°

3.7. Power Requirements

Voltage range	12 to 24 V DC
Supply current	50uA standby, 100mA active for 1 second @12V
Power source	12V DC - typically an external battery

3.8. Communications

SDI-12	SDI-12 v1.3
Connection	Single cable up to 50 metres long (standard fitment is 15m)
Maximum cable	60m defined by SDI12.org
RS-485	Modbus RTU
Connection	Single cable up to 300 metres long (standard fitment is 15m)
Baud rate and parity	Configurable

3.9. Environmental

Operating	0°C to 60°C (water temperature)
Storage	-20°C to 60°C
Humidity	up to 100 % RH

3.10. Physical

Dimensions	Approximately L 135 mm, W 55 mm, H 22 mm
Material	Epoxy-sealed body, stainless steel mount
Weight	1kg with 15m of Cable
Cable	15 metre
Cable options	User-specified, up to 50 metres

3.11. Instrument Wiring Table

Variants for Wiring are detailed below.

Brown Wire Variant

Starflow QSD / Wire Colour	Function / Signal Name
White	SDI-12
Brown	Power
Green	Ground
Yellow	A- (Modbus)
Pink	B+ (Modbus)
Grey	One-Wire *

Red Wire Variant

Starflow QSD / Wire Colour	Function / Signal Name
White	SDI-12
Red	Power
Yellow	Ground
Orange	A- (Modbus)
Blue	B+ (Modbus)
Grey	One-Wire *

* Use with Unidata 6515 QSD Barometric Reference Module

When the Unidata 6515 QSD Barometric Reference module is connected, the instrument will automatically handle the barometric correction and report the actual water level instead of the water head plus atmospheric pressure.

Suppose your data logger has a barometric sensor. In that case, the data logger program must perform the barometric correction, OR the user can perform a post-processing method to correct for barometric changes by using barometric pressure data from a trusted source such as a weather department or another barometer close by.

The 6515 QSD Barometer Reference module should be:

- a) Mounted in an enclosure near the data logger in a position protected from the elements.
- b) The enclosure should be vented to expose the barometer sensor to atmospheric pressure variations.

6515 QSD barometric Connection Diagram:

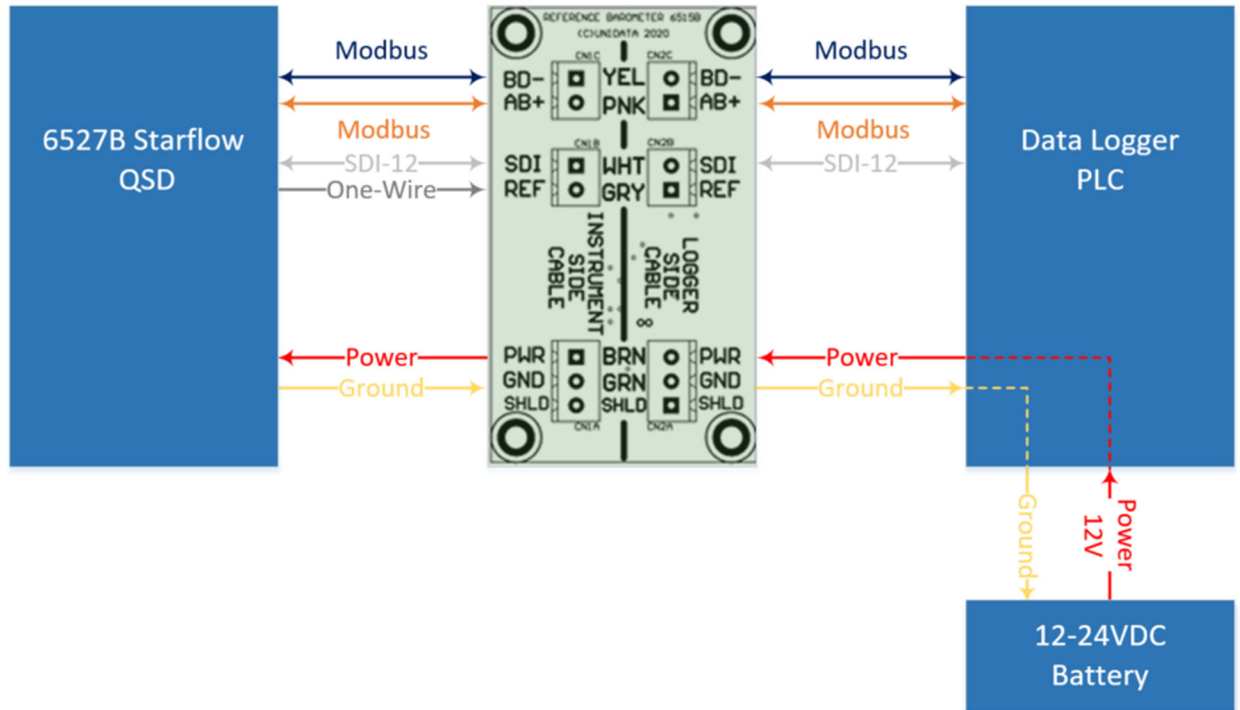

There may be a small pressure offset when the sensor is first installed due to different barometric conditions compared to the factory. This can be set to zero by applying a positive or negative offset using a Modbus or SDI-12 command. Examples in sections [5.1.3.2 \(SDI-12\)](#) and [5.2.6.2 \(Modbus RTU\)](#)

4. OPERATING PRINCIPLES & MEASURED PARAMETERS

The 6527B and 6537A Starflow QSD measure:

- Flow velocity
- Depth (ultrasonic)
- Temperature
- Depth (Pressure)
- Electrical Conductivity (EC) – 6537A Only
- Tilt (the angular orientation of the instrument)

The Starflow QSD performs data processing and analysis each time a measurement is made. This can include rolling averaging and outlier/filter functions for Depth (ultrasonic), Velocity, Depth (Pressure) and Conductivity (6537A). The function parameters can be configured via SDI-12 eXtended command or Sonic software.

4.1 Flow Velocity Measurement

For measuring velocity, the Starflow QSD uses Continuous Mode Doppler. An ultrasonic signal is transmitted into the water flow, and echoes (reflections) returned from particles suspended in the water flow are received and analysed to extract the Doppler shift (velocity). The transmission is continuous and simultaneous with the returned signal reception.

During a measurement cycle, the Starflow QSD emits a continuous signal and measures signals returning from scatterers anywhere and everywhere along the beam. These are resolved to a mean velocity that can be related to a channel flow velocity at suitable sites.

The receiver in the instrument detects reflected signals, and those signals are analysed using digital signal processing techniques.

Internally the instrument auto-scales over these ranges if the range is manually set in the settings: A bidirectional velocity capability is a supported option but needs to be configured using Modbus or SDI-12 commands as the default setting is positive flow only.

- 20mm / s to 0.8 m sec
- 20mm / s to 1.6m/s (default)
- 20mm / s to 3.2 m/s

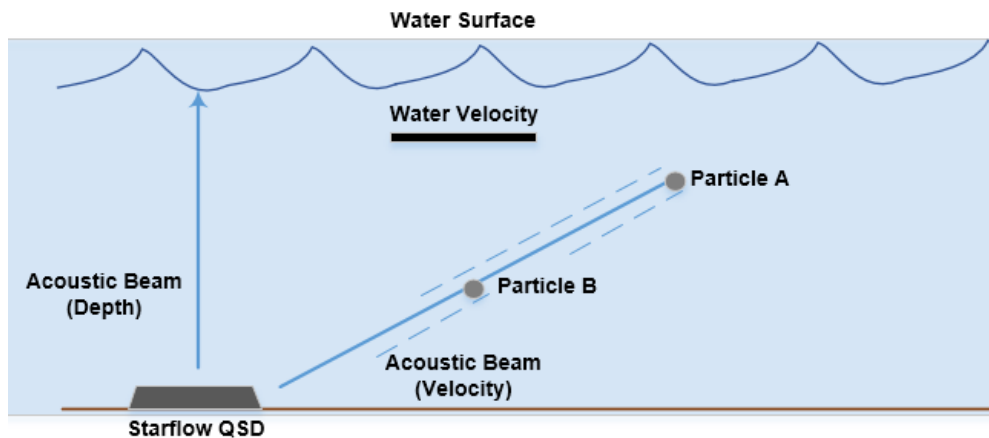

4.2 Water Depth Measurement – Ultrasonic

For depth measurement, the Starflow QSD uses Time-of-Flight (ToF) Ranging. This involves transmitting a burst of ultrasonic signal upwards to the surface of the water and measuring the time taken for the echo from the surface to be received by the instrument. The distance (water depth) is proportional to the transit time and the speed of sound in water (corrected for temperature and density). The maximum ultrasonic depth measurement is limited to 5m. The minimum ultrasonic depth is 40mm above the ultrasonic eye.

NOTE: If there is a large ripple on the surface of the water due to windy conditions, this may cause erratic Ultrasonic depth readings as it will not be able to resolve the correct reflections; in these cases, the Pressure depth sensor will need to be used.

4.3 Water Depth Measurement - Pressure

Sites where the water contains large amounts of debris or air bubbles, may be unsuited for ultrasonic depth measurement. These sites are better suited to using pressure to determine the water depth.

The pressure-based depth measurement may also be applicable to sites where the instrument cannot be located on the floor of the flow channel or cannot be mounted horizontally.

The Starflow QSD is fitted with a 2 bars absolute pressure sensor. The sensor is located on the bottom face of the instrument and utilises a temperature-compensated digital pressure sensing element.

Where depth pressure sensors are used, the atmospheric pressure variation will cause errors in the indicated depth. This is corrected by subtracting the atmospheric pressure from the measured depth pressure. A barometric pressure sensor is required to do this.

If the data logger used to read the Starflow QSD does not incorporate a barometric pressure sensor, then the One Wire Bus 6515 Reference Barometer option should be purchased.

6515 should be mounted near the logger and is read by the Starflow QSD instrument, which will then automatically compensate for the atmospheric pressure variations ensuring an accurate depth measurement is achieved. This enables Starflow QSD to report actual water depth (pressure) instead of barometric pressure plus water head.

4.4 Temperature

A solid-state temperature sensor is used to measure the water temperature. The speed of sound in water and its conductivity are affected by temperature. The instrument uses this measured temperature to compensate for temperature variations automatically.

4.5 Electrical Conductivity EC 6537A Only

The 6537A Starflow QSD is equipped with the capacity to measure the conductivity of the water. A linear four-electrode configuration is used to make the measurement. A small current is passed through the water, and the voltage developed by this current is measured. The instrument uses these values to calculate the raw uncorrected conductivity.

Conductivity is dependent on the temperature of the water. The instrument uses the measured temperature to compensate for the returned conductivity value. Both raw and temperature-compensated conductivity values are available.

4.6 Accelerometer

The Starflow QSD has an integral accelerometer sensor to measure the inclination of the instrument. The sensor returns the roll and pitch angle of the sensor (in degrees). This information can be useful in ensuring the installation position of the sensor is correct and for determining if the instrument has moved (bumped or washed away) during the post-installation inspection.

4.7 Power Supply Voltage

The instrument's internal power supply voltage is readable as a measurement parameter. The operating range of the power supply is 12 to 24V DC. If the supply voltage falls below defined limits, the instrument stops taking measurements to ensure only quality data is measured.

4.8 Signal Spread

This can be used to determine the amount of “turbulence” affecting the signal quality and used to reject the measurement if the spread (turbulence) is too great. A good flow would return a spread value of around 50; anything above 100 would be considered poor.

Spread Channel Interpretation:

0-50	Excellent SPREAD
60-200	Average SPREAD
200-500	Poor SPREAD
Above 500	Above 500 gives unreliable velocity data.

4.9 Received Signal Strength Indicator (RSSI)

The RSSI channel is the measurement of the received signal power. RSSI values may change significantly for each measurement because of the number of reflectors in the water at any given time.

In turbulent water, the reflectors are more likely to be in suspension, resulting in higher signal/RSSI values. Subsequently, the smoother flowing water “may” have fewer reflectors and lower signal/RSSI values. However, signal/RSSI values are dependent, not only on the turbulence but on fluid velocity as well.

RSSI Channel Interpretation:

0	No Signal
3-200	Typical signal in water
>1000	Not usable Signal (Too Noisy)

5. TAKING MEASUREMENTS FROM INSTRUMENT

The Starflow QSD instrument has both SDI-12 and RS485 (Modbus RTU) Interfaces. The following sections describe them in detail. If you are a user of Unidata NRL loggers, you can simply add the Starflow QSD as an instrument within the logging scheme as an SDI-12 instrument.

5.1. SDI-12 Operation

The Starflow QSD can be operated as a standard SDI-12 (V1.3) sensor.

Measurement commands (M! & C!) return attn(n) response with ttt indicating the delay until measurements are ready and n(n) indicates the number of parameters returned.

A Service Request is sent.

- The R! command returns an acknowledge response a<CR><LF>
- The D! command returns the measured data values.

SDI-12 Command Notes:

1. Change Address aAb! is supported.
2. Start Verification aV! returns an acknowledge response.
3. Extended Command aX is supported (refer to QSD SDI-12 supplement document).
4. D/R1...9! Commands operate the same as a D/R0! command.
5. M/C1...9! Commands operate the same as an M/C! command.
6. MC, CC & RC commands requesting CRC are supported.

Note: CRC is always recommended

5.1.1. Channels Table

The Starflow QSD has a list of data registers within the instrument that are re-mapped to SDI-12 channels. These SDI-12 parameters are assigned to the Channels, and their order of return can be configured using SDI-12 eXtended commands. The channel allocation is shown in the below table:

Channel	Description	Units	Example	Meaning
0	Water Temperature	1/10 °C	+152	15.2°C
1	Battery Voltage	1/100 Volts	+1302	13.02Volts
2	Ultrasonic Depth	mm	+123	123mm
3	CW Water Velocity	+/- mm/s	-234	234mm/s -ve flow
4	RSSI (signal level)	no units	+66	66 (no units)
5	Signal Spread	no units	+45	45 (no units)
10	X-Axis Tilt	+/- deg	-9	9 deg left tilt
11	Y-Axis Tilt	+/- deg	7	7 deg forward tilt
12	Pressure Depth	+/- mm	+123	123mm
13	Barometric Reference	+ mm	+10120	10120mm
70	Conductivity (UC)	µS/cm	+2350	2350µS/cm
72	Conductivity (TC)	µS/cm	+2350	2350µS/cm

5.1.2. Measurement Command (aM!)

6527B/6537A Starflow QSD measures several parameters available for collection by a data logger. The default configuration returns nine parameters using the **aM!** command. Other sets of parameters are also available using the **aMx!** commands.

Example 1: aM!

Parameter	Description	Units	Example	Meaning
1	Water Temperature	1/10 °C	+152	15.2°C
2	Battery Voltage	1/100 Volts	+1302	13.02Volts
3	Ultrasonic Depth	mm	+123	123mm
4	CW Water Velocity	+/- mm/s	-234	234mm/s -ve flow
5	RSSI (signal level)	no units	+66	66 (no units)
6	Signal Spread	no units	+45	45 (no units)
7	Conductivity (TC)	µS/cm	+2350	2350µS/cm
8	Pressure Depth	+/- mm	+123	123mm
9	Barometric Reference	+ mm	+10120	10120mm

Start Measurement Command (aM!) example:

0M! 00059 <CR><LF> (Measurement ready in 5 seconds and nine parameters available)

0D0! 0+152+1302+123+234+66+45+2340+123+10120 <CR><LF>

Example 2: aM1! (Firmware 20 and above)

Parameter	Description	Units	Example	Meaning
1	Water Temperature	1/10 °C	+152	15.2°C
2	Battery Voltage	1/100 Volts	+1302	13.02Volts
3	Ultrasonic Depth	mm	+123	123mm
4	CW Water Velocity	+/- mm/s	-234	234mm/s -ve flow

Start Measurement Command (aM1!) example:

0M1! 00054 <CR><LF> (Measurement ready in 5 seconds and 4 parameters available)

0D0! 0+213+1343+123+234<CR><LF>

Example 3: aM2! (Firmware 20 and above)

Parameter	Description	Units	Example	Meaning
1	Pressure Depth	+/- mm	+123	123mm
2	Barometric Reference	+ mm	+10120	10120mm

Start Measurement Command (aM2!) example:

0M2! 00052 <CR><LF> (Measurement ready in 5 seconds and 2 parameters available)

0D0! 0+123+10120 <CR><LF>

Example 4: aM3! (Firmware 20 and above)

Parameter	Description	Units	Example	Meaning
1	Conductivity (UC)	µS/cm	+2350	2350µS/cm
2	Conductivity (TC)	µS/cm	+2350	2350µS/cm

Start Measurement Command (aM3!) example:

0M3! 00052 <CR><LF> (Measurement ready in 5 seconds and 2 parameters available)

0D0! 0+2350+2350 <CR><LF>

Example 5: aM4! (Firmware 20 and above)

Parameter	Description	Units	Example	Meaning
1	X-axis Tilt	+/- deg	-9	9 deg left tilt
2	Y-axis Tilt	+/- deg	7	7 deg forward tilt

Start Measurement Command (aM4!) example:

0M4! 00052 <CR><LF> (Measurement ready in 5 seconds and 2 parameters available)

0D0! 0-9+7 <CR><LF>

Example 6: aM5! (Firmware 20 and above)

Parameter	Description	Units	Example	Meaning
1	RSSI (signal level)	no units	+66	66 (no units)
2	Signal Spread	no units	+45	45 (no units)

Start Measurement Command (aM5!) example:

0M5! 00052 <CR><LF> (Measurement ready in 5 seconds and 2 parameters available)

0D0! 0+66+45 <CR><LF>

Note: More information on C! And R! Commands can be found in the QSD SDI-12 supplement document.

5.1.3. Additional SDI-12 Commands

5.1.3.1. Operation Mode

0 = SDI-12

5 = 5 second Modbus scan update or as per how often the Modbus registers are required to update (5 is the minimum value)

Example 1 Examine:

Send – 0X8! <CR><LF>

Response – 0+0<CR><LF>

Example 2 Change:

Send – 0X8+5! <CR><LF>

Response - 0+5<CR><LF>

5.1.3.2. Pressure Depth Zero Offset

Example 1 Examine:

Send – 0X7! <CR><LF>

Response – 0+30<CR><LF> The current pressure depth offset setting is 30mm.

Example 2 Change:

Send – 0X7+100! <CR><LF>

Response - 0+100<CR><LF> Set pressure depth offset to 100mm.

Example 3 Change:

Send – 0X7-100! <CR><LF>

Response – 0-100<CR><LF> Set pressure depth offset to -100mm.

5.1.3.3. Enable Velocity Direction

Example Change (negative and positive velocity direction):

Send – 0X5+26! <CR><LF>

Response – 0+0+4+5+7+8+16+17+18+19+20+21+22+24+26+27+30<CR><LF>

5.1.3.4. Changing Velocity Range

2 = 3345mm/s

3 = 1673mm/s (Default)

4 = 836mm/s

5 = 418mm/s

Example 1 Examine:

Send – 0X9! <CR><LF>

Response – 0+3<CR><LF> (Range reported as 3 – 1673mm/Sec)

Example 2 Change:

Send – 0X9+5! <CR><LF>

Response - 0+5<CR><LF> (Change range to 5 – 418mm/Sec)

5.1.4. Unidata Logger SDI-12 Scheme Setup

The Starflow QSD can be directly connected to the Unidata NRL Logger range using SDI-12. A scheme can then be set up using the StarlogV4 software to record the parameters from the QSD and to enter the channel profile for flow calculations.

1. Create a new scheme and select the logger, e.g., 3004M.

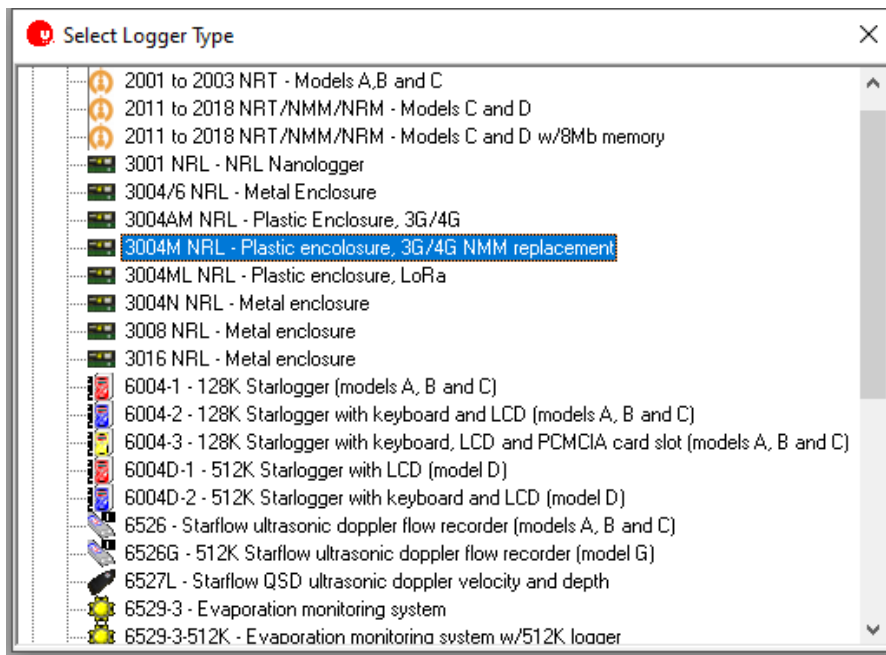

2. Click on the Instruments button and select the PDLTrans Library in the drop-down menu.

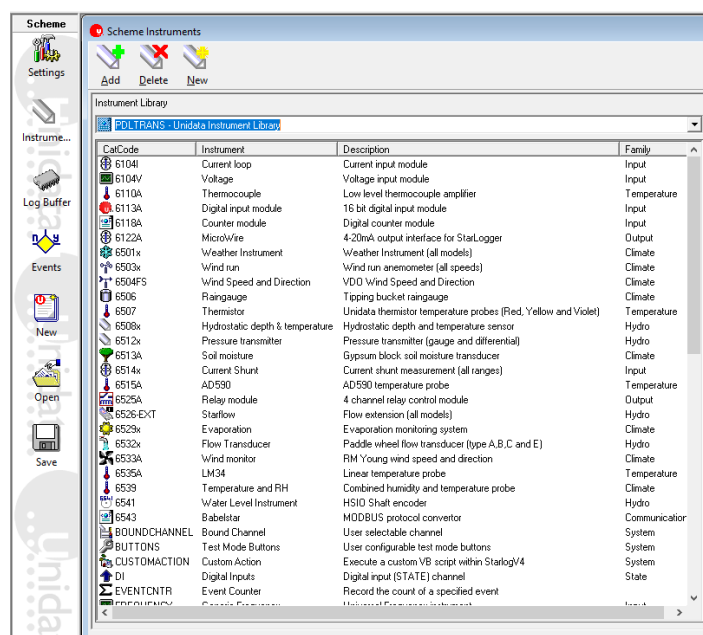

3. Scroll down and double-click SDITASK Instrument, and it will be added to the window on the right.

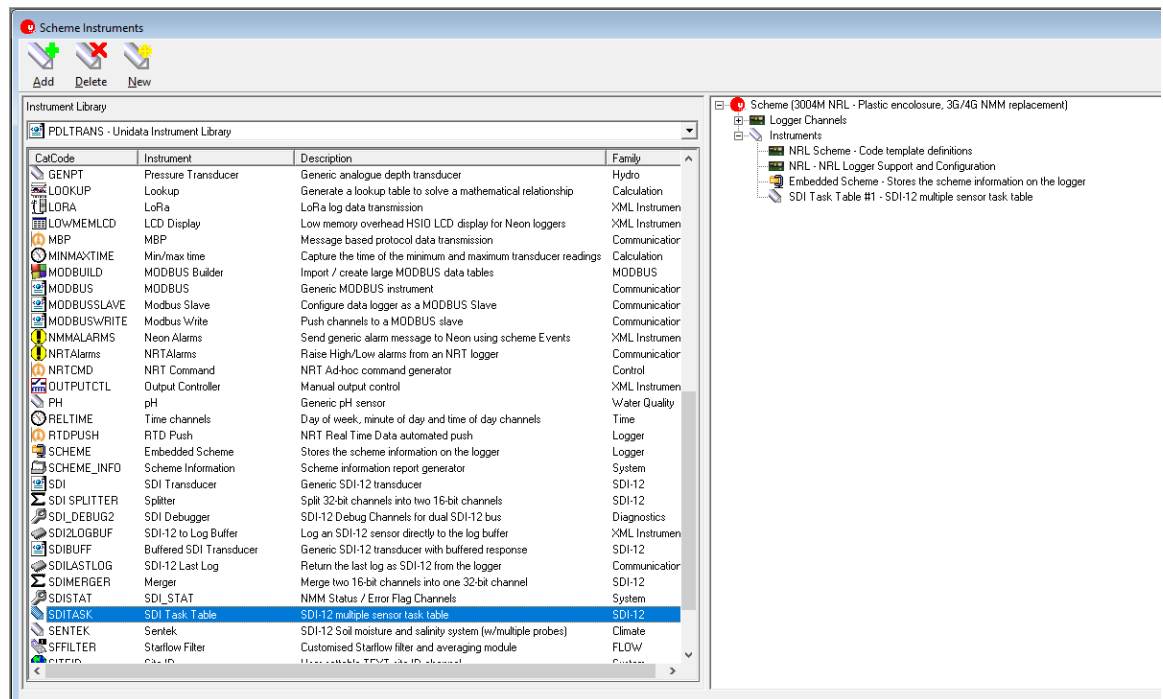

4. Double-click on the 6526-EXT instrument to add the Flow Extension, and it will be added to the window on the right.

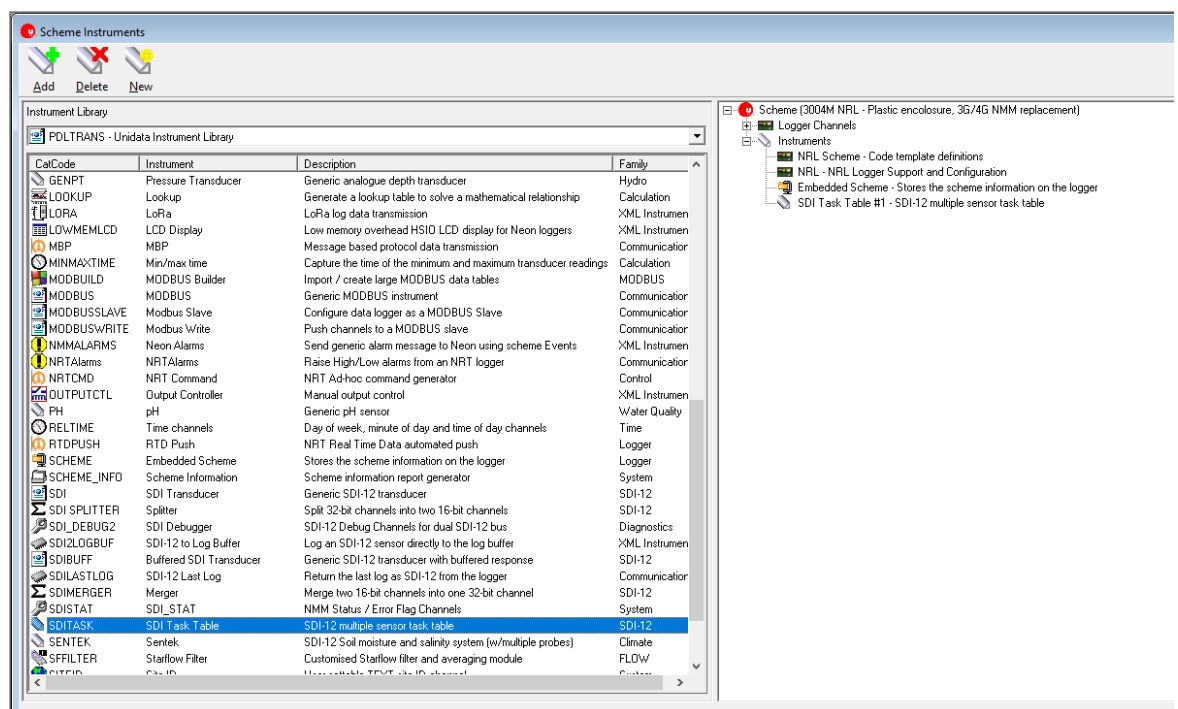

- Double-click on the SDI Task Table #1 Instrument in the right window

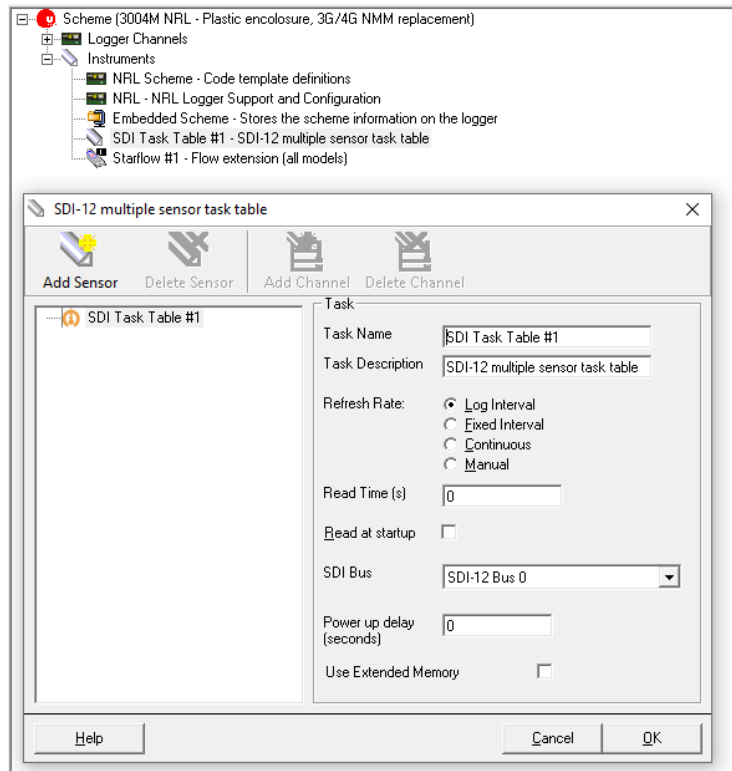

- Click the Add Sensor button, scroll down in the list, select the Unidata 6537 QSD and click Ok.

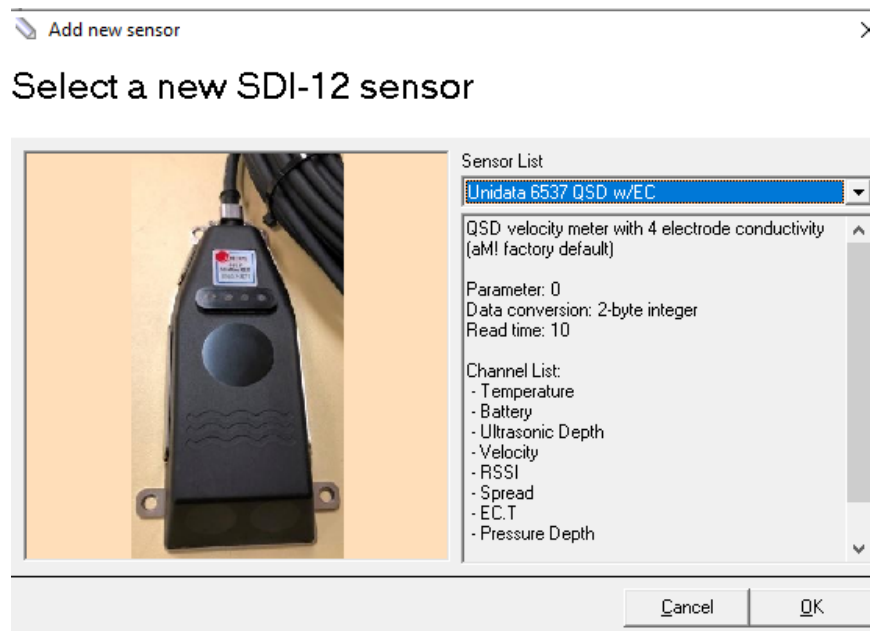

- Set to Log Interval and set Read Time to 10s (The Starflow QSD will take 5s to take measurements); make sure the Read Time is a multiple of the Scan Rate.

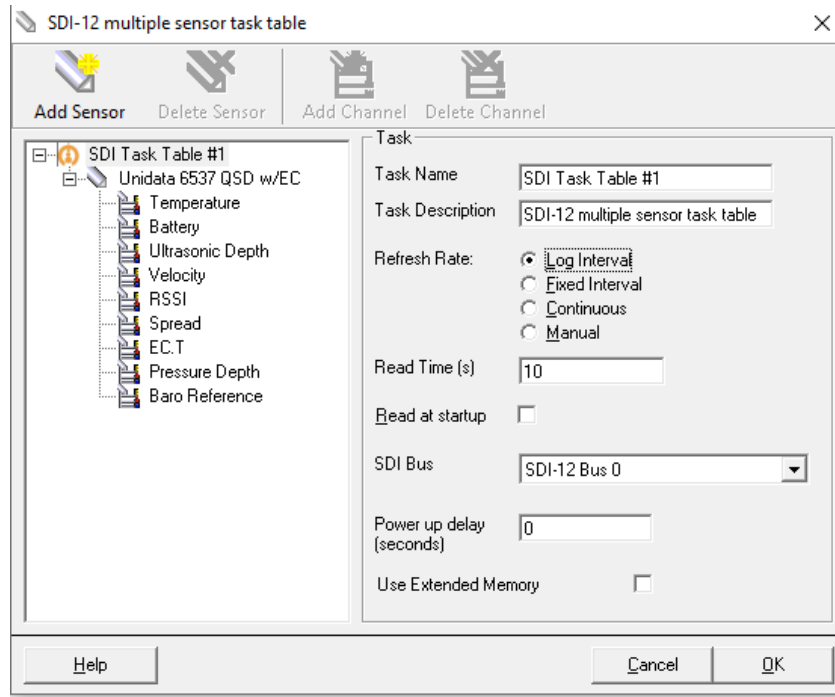

- Set the Instrument to use CRC.

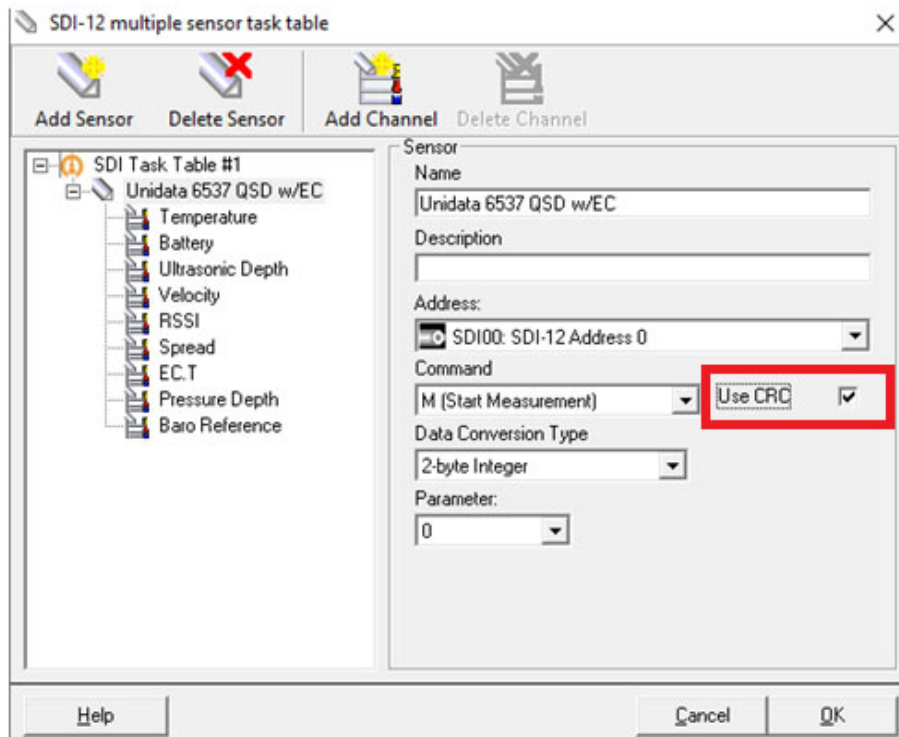

- Open the Flow extension instrument and set up the channel profile; select the Input Depth channel to be Ultrasonic OR Pressure Depth depending on the site installation and select the Input Velocity Channel to be Velocity.

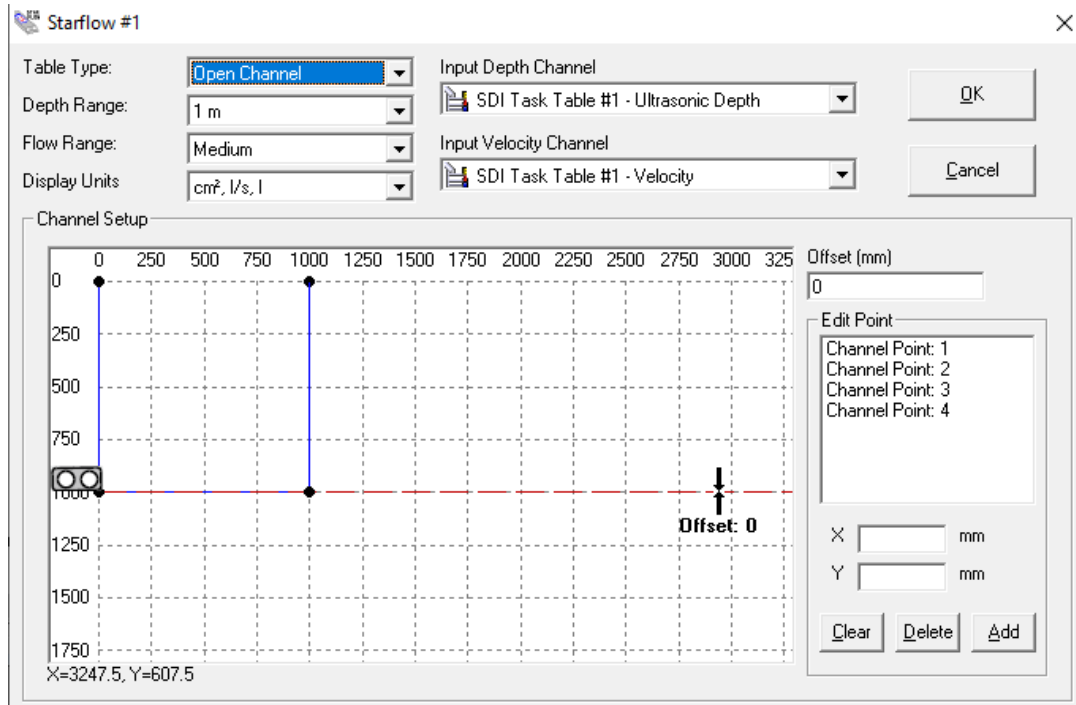

- Open the Log Buffer and enable the log channels required.

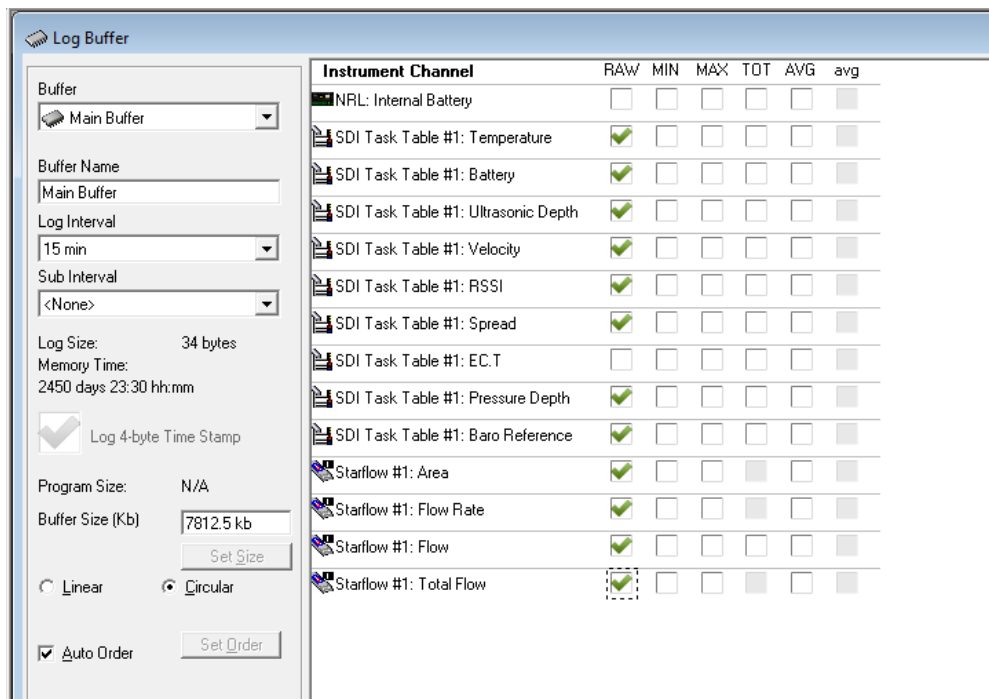

5.2. Modbus RS485 Operation

The Starflow QSD can be operated as a Modbus RTU Slave sensor. The Baud rate and parity selected must be configured prior to using the instrument. The instrument supports configurable Baud rates for the RS-485 Communication Port (the SDI-12 Port is fixed to 1200/9600 as per the SDI-12 standard). There are two configuration parameters (baud rate & parity), and these may be changed via Modbus commands.

When changing these, the new settings come into effect AFTER the response has been sent to the Modbus PC utility. To continue communicating via RS-485, the PC utility's baud rate settings MUST then be changed to match that of the Starflow QSD.

RS485 Baud rate and Parity setting options can be configured using Modbus commands (refer to QSD Modbus supplement document).

5.2.1. Reading the measured parameters via Modbus

Physical links requirement: RS485 - low power, 2V, three-wire (A/B signals & ground), differential, half-duplex; at 9600bps (support up to 1000m cable, at 19200bps up to 500m cable, at 115Kkps up to 100m cable) and it supports PP, MD & MP protocols.

Protocol requirement: MODBUS (Modicon) - variable speed (9600 & 19200), MD over RS485. For PC configuration, a USB to RS485 converter is required. The instrument must be powered via 12V and ground; A- and B+ signals will need to be connected as per the wiring table in specifications [section 2.0](#).

The instrument supports the **Modbus RTU communication protocol**; this is the format of choice for serial communications, such as RS485/RS232, as it is the most efficient. The general message structure will consist of the device address, function code, data payload and checksum.

5.2.2. Master Format

Device Address	Function Code	Data Payload	CRC
----------------	---------------	--------------	-----

Device address – 1 byte field ranging from 1 to 247. Broadcast address 0

Function code – 1 byte field with a value range 1-127 representing the standard or extended function code

Data payload – 0-N bytes with response data from the device. Error response will be a 1 byte value 1-255.

CRC – 2 bytes computed mathematically.

5.2.3. Slave Response Format

Device Address	Function Code	Data Payload	CRC
-----------------------	----------------------	---------------------	------------

Device Address – Echo of the device address sent in the master message to the device.

Function code – Echo of function code sent in the master message to the device.

Data payload – 0-N bytes with the response from the device.

CRC - 2 bytes with a value computed mathematically.

5.2.4. Standard Message Format

Read Holding Registers are used to retrieve measurements.

Message		
Address	1 byte	1-247
Function Code	1 byte	0x03
Data Address	2 bytes	0 to 0xFFFF
Register Count	2 bytes	
CRC	2 bytes	

Response		
Address	1 byte	1-247
Function Code	1 byte	0x03
Byte Count	1 byte	
Data Payload	N bytes	
CRC	2 bytes	

**Byte count = 2*Register Count*

Write Single Register is used to configure instrument settings.

To set a single register in a device:

Message		
Address	1 byte	1-247
Function Code	1 byte	0x06
Data Address	2 bytes	0 to 0xFFFF
Register Count	2 bytes	0 to 0xFFFF
CRC	2 bytes	

Response		
Address	1 byte	1-247
Function Code	1 byte	0x06
Byte Count	1 byte	0 to 0xFFFF
Data Payload	N bytes	0 to 0xFFFF
CRC	2 bytes	

RS485 Settings

Baud rates – Support Baud rates from 9600 to 115200

Data Bits – 8 data bits (7 data bits is not a valid setting for Modbus RTU)

Parity Bits – Even, Odd and None

Stop Bits – 1 or 2

***Default settings will be 9600,8,N,1.**

5.2.5. Modbus Registers

The below list of parameters will all be located in the holding registers.

Sensor Common Registers: Registers Numbered 0001 to nnnn have Data Addresses 0000 to nnnn-1

Register XXXX	Size (Reg)	Mode/Access	Data Type	Description
0001	1	Read only	ushort	Water Temperature * 0.1 DegC
0002	1	Read only	ushort	Battery Voltage * 0.01 Volts
0003	1	Read only	ushort	Water Depth (Ultrasonic) mm
0004	1	Read only	sshort	CW Water Velocity mm/s
0005	1	Read only	ushort	RSSI
0006	1	Read only	ushort	Signal Spread
0007	1	Read only	ushort	EC Conductivity Un-Corrected
0008	1	Read only	ushort	EC Hi-Resolution Un-Corrected
0009	1	Read only	ushort	EC Conductivity Temperature Corrected
0010	1	Read only	ushort	EC Hi-Resolution Temperature Corrected
0011	1	Read only	sshort	Accelerometer X +/- 90 deg
0012	1	Read only	sshort	Accelerometer Y +/- 90 deg
0013	1	Read only	sshort	Water Depth (Pressure) mm
0014	1	Read only	ushort	OWB Barometric Reference mm
0015	1	Read only	sshort	PW Velocity in +/- mm/s

Example 1: Water Temperature

Send - 01 03 00 00 00 01 84 0A

Receive - 01 03 02 00 DC B9 DD

00 DC = 220

Temperature = 220 x 0.1 = 22.0 °C

Example 2: Water Temperature, Battery Voltage, Water Depth, Velocity, RSSI, Signal Spread

Send - 01 03 00 00 00 06 C5 C8

Receive - 01 03 0C 00 DF 05 3F 00 8D 00 55 00 10 00 18 5E 8D

00 DF = 223

Temperature = 223 x 0.1 = 22.3 °C

05 3F = 1343

Battery = 1343 x 0.01 = 13.43 V

00 8D = 141

Water depth (Ultrasonic) = 141 mm

00 55 = 85

CW water Velocity = 85 mm/s

00 10 = 16

RSSI = 16

00 18 = 24

Signal Spread = 24

Note: Refer to the Starflow QSD Modbus supplement document for additional information

5.2.6. Additional Modbus Commands

5.2.6.1. Operation Mode

0 = SDI-12

5 = 5 second Modbus scan update or as per how often the Modbus registers are required to update (5 is the minimum value)

Example: Set Modbus 5 second update (default):

Send - 01 06 00 64 00 05 08 16

Receive - 01 06 00 64 00 05 08 16

5.2.6.2. Pressure Depth Zero Offset

Example 1: Set pressure depth offset 100mm:

Send - 01 06 00 6D 00 64 19 FC

Receive - 01 06 00 6D 00 64 19 FC

Example 2: Set pressure depth offset -10363mm:

Send - 01 06 00 6D D7 85 86 44

Receive - 01 06 00 6D D7 85 86 44

5.2.6.3. Enable Velocity Direction

Example 1 Change (Enable negative velocity direction):

Send - 01 06 00 E2 00 01 E8 3C

Receive - 01 06 00 E2 00 01 E8 3C

Example 2 Change (Disable negative velocity direction):

Send - 01 06 00 E2 00 00 29 FC

Receive - 01 06 00 E2 00 00 29 FC

5.2.6.4. Changing a velocity range

2 = 3345mm/s

3 = 1673mm/s (Default)

4 = 836mm/s

5 = 418mm/s

Example Change (Change Velocity Range from 1673mm/s to 3345mm/s):

Send - 01 06 00 6C 00 02 C8 16

Receive - 01 06 00 6C 00 02 C8 16

5.2.7. Unidata Logger Modbus Scheme Setup

The Starflow QSD can directly connect to the Unidata NRL Logger range using SDI-12. A scheme can then be set up using the StarlogV4 software to record the parameters from the QSD and also to enter the channel profile for flow calculations.

1. Create a new scheme and select the logger, e.g., 3004M.

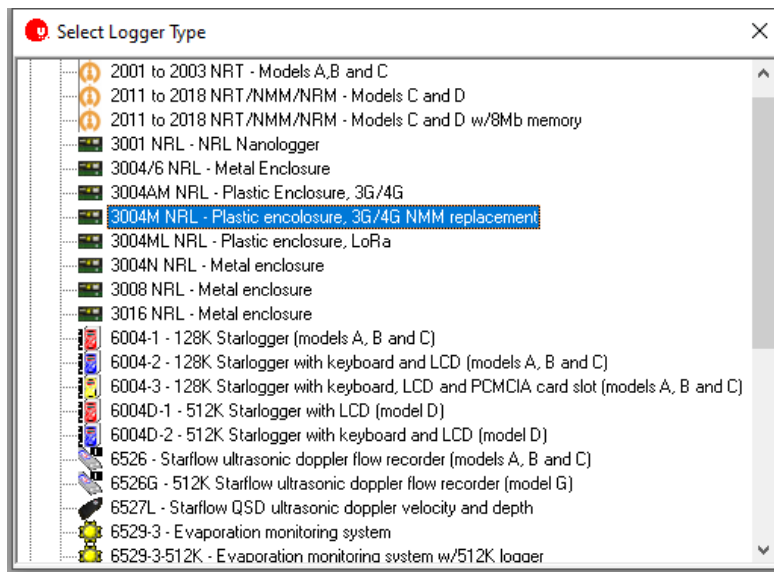

2. Click on the Instruments button and select the PDLTrans Library in the drop-down menu.

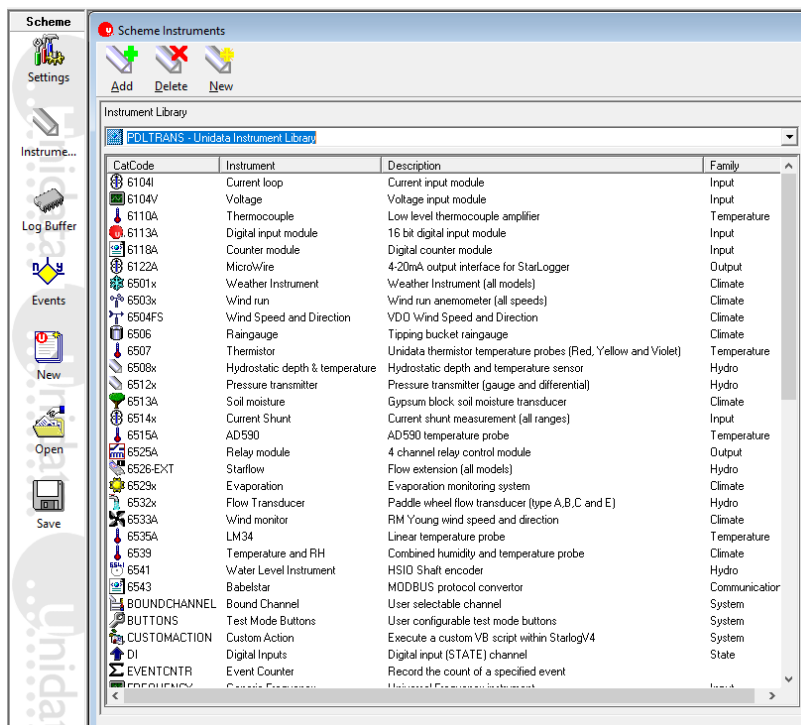

3. Scroll down and double-click the MODBUS Instrument, and it will be added to the window on the right.

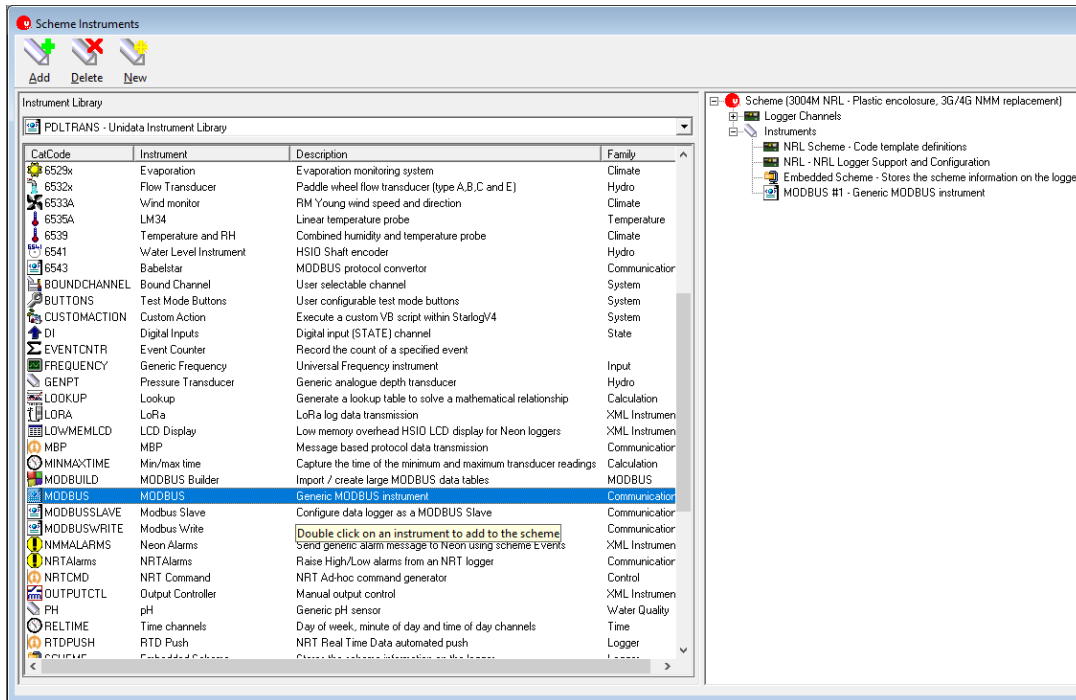

4. Double-click on the 6526-EXT instrument to add the Flow Extension, and it will be added to the window on the right.

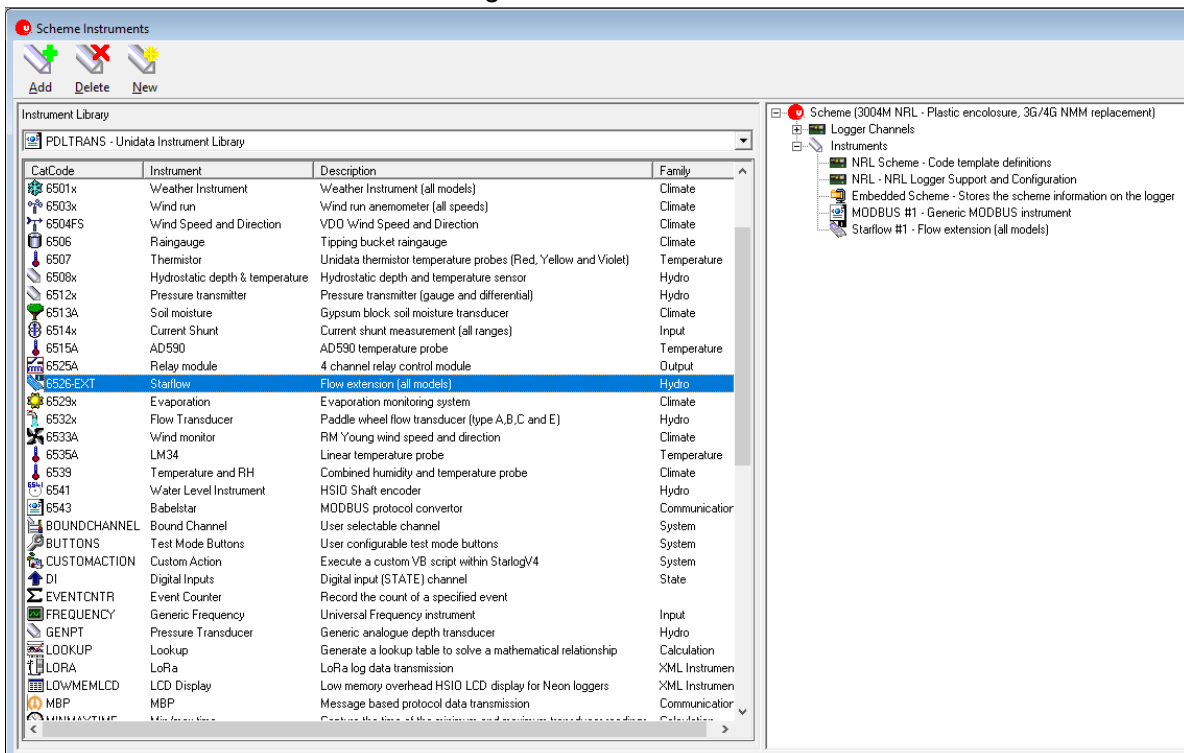

5. Double-click on the MODBUS #1 Instrument in the right window

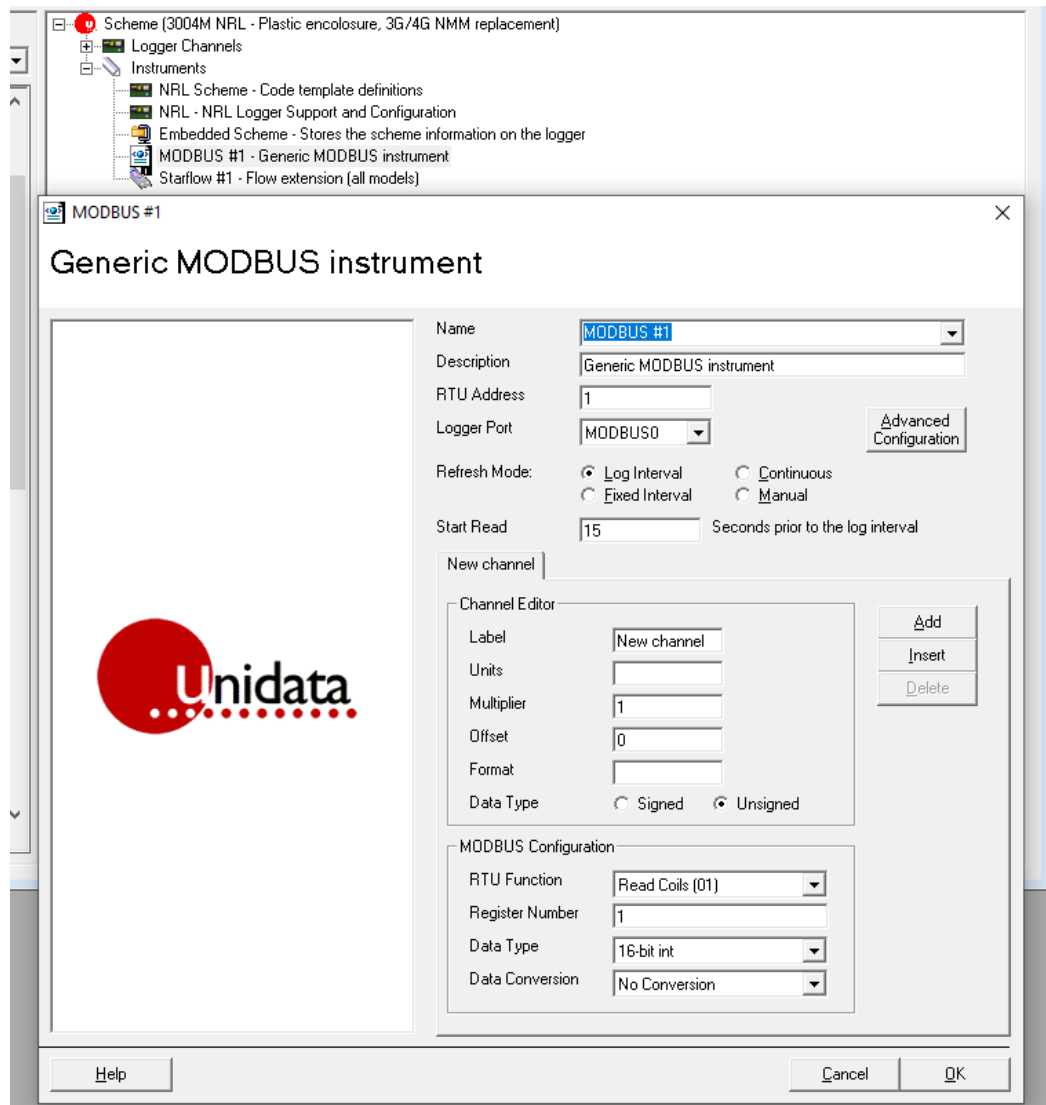

6. Scroll down in the Name list and select the Unidata 6527/6537 QSD and click Ok.

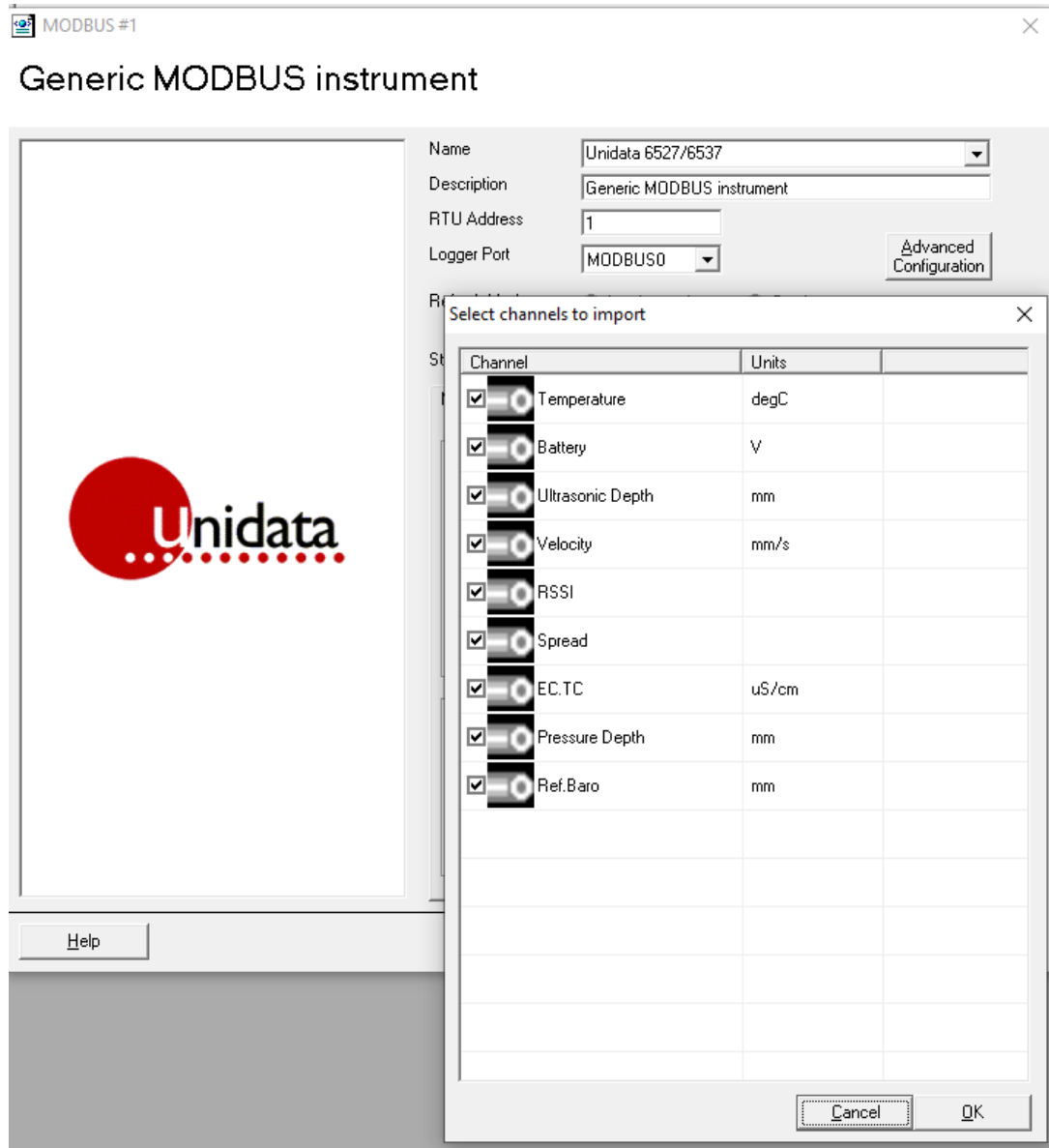

- Set to Log Interval and set Read Time to 10s (The Starflow QSD will take 5s to take measurements); make sure the Read time is a multiple of the scan rate.



- Open the Flow extension instrument and set up the channel profile, select the Input Depth channel to be Ultrasonic OR Pressure Depth depending on the site installation and select the Input Velocity Channel to be Velocity.

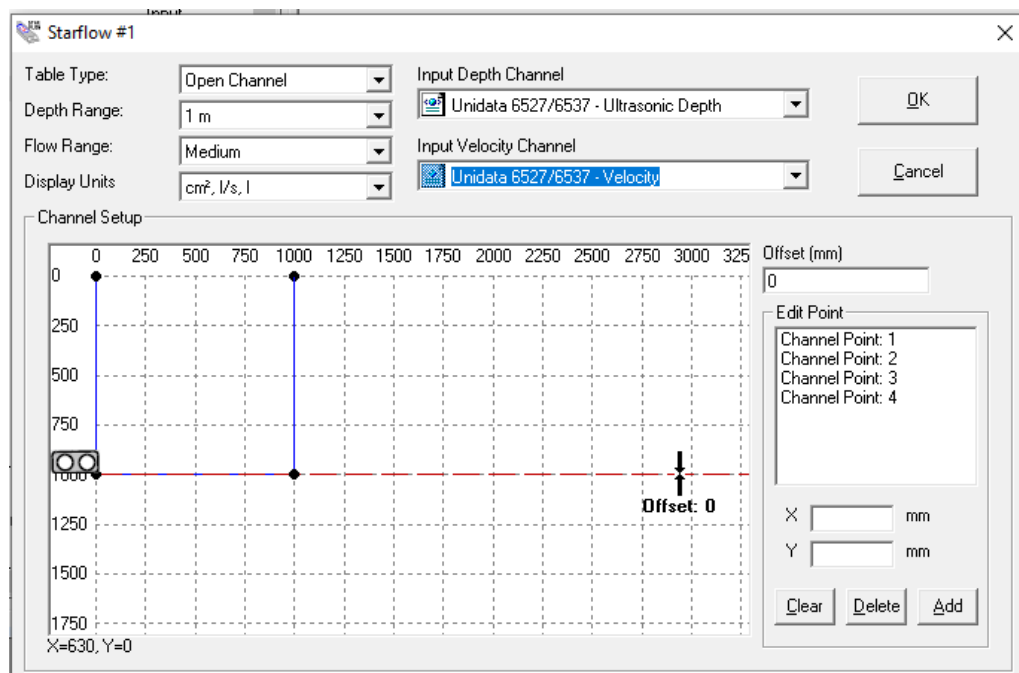

- Open the Log Buffer and enable the log channels required; if your instrument model is 6527, then there will be no conductivity reading.

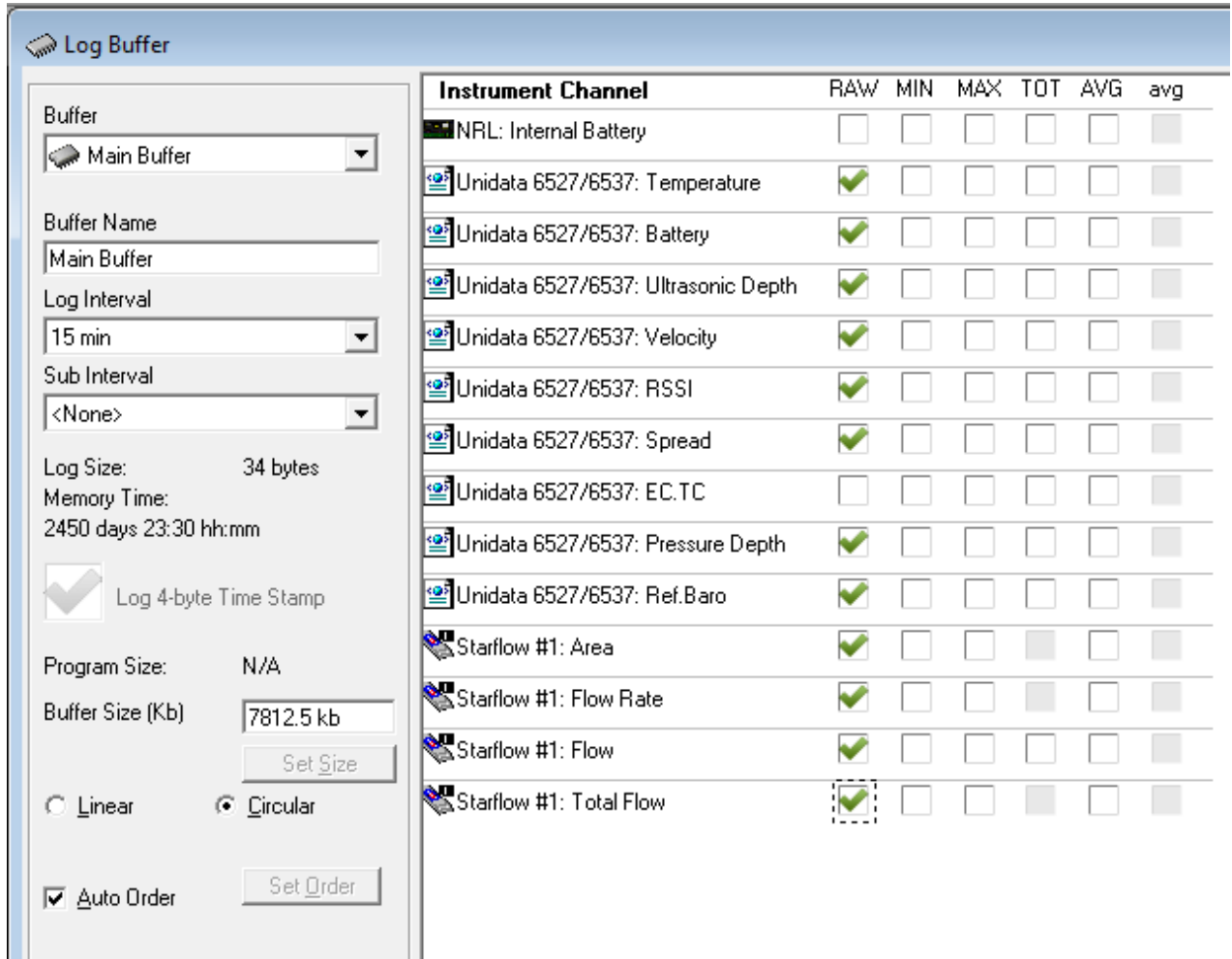

The screenshot shows the 'Log Buffer' configuration window. On the left, there are settings for the buffer: Buffer (Main Buffer), Buffer Name (Main Buffer), Log Interval (15 min), Sub Interval (<None>), Log Size (34 bytes), Memory Time (2450 days 23:30 hh:mm), Log 4-byte Time Stamp (checked), Program Size (N/A), Buffer Size (7812.5 kb), and options for Linear/Circular logging and Auto Order (checked).

Instrument Channel	RAW	MIN	MAX	TOT	AVG	avg
NRL: Internal Battery	<input type="checkbox"/>	<input type="checkbox"/>	<input type="checkbox"/>	<input type="checkbox"/>	<input type="checkbox"/>	<input type="checkbox"/>
Unidata 6527/6537: Temperature	<input checked="" type="checkbox"/>	<input type="checkbox"/>	<input type="checkbox"/>	<input type="checkbox"/>	<input type="checkbox"/>	<input type="checkbox"/>
Unidata 6527/6537: Battery	<input checked="" type="checkbox"/>	<input type="checkbox"/>	<input type="checkbox"/>	<input type="checkbox"/>	<input type="checkbox"/>	<input type="checkbox"/>
Unidata 6527/6537: Ultrasonic Depth	<input checked="" type="checkbox"/>	<input type="checkbox"/>	<input type="checkbox"/>	<input type="checkbox"/>	<input type="checkbox"/>	<input type="checkbox"/>
Unidata 6527/6537: Velocity	<input checked="" type="checkbox"/>	<input type="checkbox"/>	<input type="checkbox"/>	<input type="checkbox"/>	<input type="checkbox"/>	<input type="checkbox"/>
Unidata 6527/6537: RSSI	<input checked="" type="checkbox"/>	<input type="checkbox"/>	<input type="checkbox"/>	<input type="checkbox"/>	<input type="checkbox"/>	<input type="checkbox"/>
Unidata 6527/6537: Spread	<input checked="" type="checkbox"/>	<input type="checkbox"/>	<input type="checkbox"/>	<input type="checkbox"/>	<input type="checkbox"/>	<input type="checkbox"/>
Unidata 6527/6537: EC.TC	<input type="checkbox"/>	<input type="checkbox"/>	<input type="checkbox"/>	<input type="checkbox"/>	<input type="checkbox"/>	<input type="checkbox"/>
Unidata 6527/6537: Pressure Depth	<input checked="" type="checkbox"/>	<input type="checkbox"/>	<input type="checkbox"/>	<input type="checkbox"/>	<input type="checkbox"/>	<input type="checkbox"/>
Unidata 6527/6537: Ref.Bar	<input checked="" type="checkbox"/>	<input type="checkbox"/>	<input type="checkbox"/>	<input type="checkbox"/>	<input type="checkbox"/>	<input type="checkbox"/>
Starflow #1: Area	<input checked="" type="checkbox"/>	<input type="checkbox"/>	<input type="checkbox"/>	<input type="checkbox"/>	<input type="checkbox"/>	<input type="checkbox"/>
Starflow #1: Flow Rate	<input checked="" type="checkbox"/>	<input type="checkbox"/>	<input type="checkbox"/>	<input type="checkbox"/>	<input type="checkbox"/>	<input type="checkbox"/>
Starflow #1: Flow	<input checked="" type="checkbox"/>	<input type="checkbox"/>	<input type="checkbox"/>	<input type="checkbox"/>	<input type="checkbox"/>	<input type="checkbox"/>
Starflow #1: Total Flow	<input checked="" type="checkbox"/>	<input type="checkbox"/>	<input type="checkbox"/>	<input type="checkbox"/>	<input type="checkbox"/>	<input type="checkbox"/>

- Save the scheme and exit the scheme editor.

6. INSTALLATION

6.1. Site Considerations

The Doppler signal received, and the accuracy of the computed velocity is related to the flow and cross-section characteristics of the site. A suitable site has the following features:

Feature	Description
Flows are laminar, and the velocity measured by the transducer can be related to the mean velocity of the channel.	Velocity is measured from a limited path in front of and above the acoustic sensors. This area varies with the amount of suspended material in the water and the channel characteristics. The user has to determine the relationship between the measured and mean velocity.
The channel cross-section is stable.	The relationship between the water level and the cross-sectional area is used as part of the flow computation.
Velocities are greater than 20 mm/second.	The transducer does not process velocities slower than this. The maximum velocity is 5 metres/second. The transducer will measure velocities in both directions.
Reflectors are present in the water.	Generally, the more material in the water, the better. Starflow QSD generally works well in clean natural streams, but problems may be encountered in extremely clean water, such as snow melt.
No excessive aeration	Bubbles are good scatterers, and occasional small bubbles will enhance the signal. However, the speed of sound can be affected if there are excessive amounts of air entrapped in the flow.
The bed is stable, and Starflow QSD will not be buried by deposits.	Some coating and partial burying have little effect on the measured velocity, but they should be avoided. Any burying or sediment covering the depth transducer will affect the depth reading results.
Starflow QSD Pointing Upstream or Downstream?	Pointing the sensor end downstream will stop it from accumulating debris; however, in some channels, the sensor body may disturb the velocity distribution unacceptably. The velocity reading will be positive when pointing upstream and negative when pointing downstream. The Starflow QSD may be configured to only read positive velocities regardless of water flow direction.
Starflow QSD Depth sensor not situated parallel to the surface?	If the Depth sensor is not parallel to the surface ($\sim \pm 10^\circ$), the readings could be compromised.
Corrugated Pipes	In general, the Starflow QSD is not suited to installation in corrugated pipes.

6.2. Instrument Mounting – Pipes & Culverts

A typical installation is in a pipe or culvert with diameters between 150mm and 2000 mm. The Starflow QSD should be located near the downstream end of a straight and clean culvert, where non-turbulent flow conditions are maximised. The mounting should ensure the unit sits right on the bottom to avoid debris catching beneath it.

It is recommended that in open pipe situations, the instrument is situated five times the diameter from the opening or discharge. This will allow the instrument to measure the best possible laminar flow. Keep the instrument away from pipe joints. Corrugated culverts are not suitable for Starflow QSD instruments.

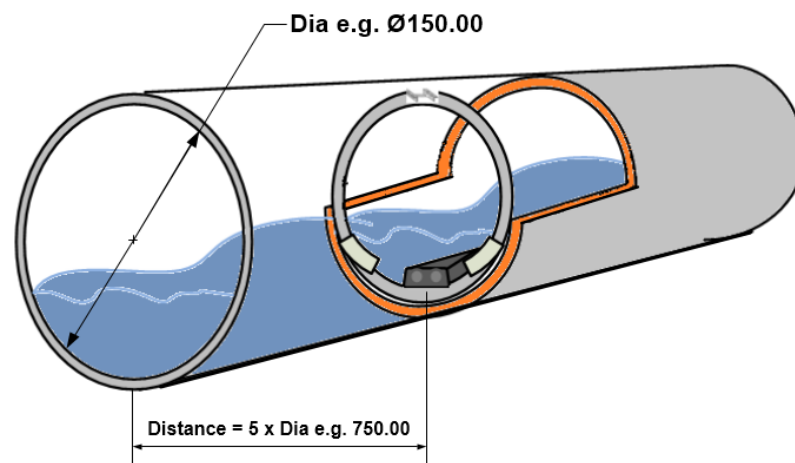

Diagram showing instrument five diameters in from pipe opening.

In culverts, the sensor can be mounted on a stainless-steel band that is slipped inside the pipe and expanded to lock it in position. In open channels, special mounting brackets may be required.

The Model 6705 Expanding Band kit allows you to install a Starflow QSD instrument into a pipe. The kit design is modular, allowing it to fit into any size pipe. The band is flexible enough to fit irregular shapes, such as ovoid (egg-shaped) sections. All components are made from stainless steel, and the band fittings are 100mm wide to fit the standard Starflow QSD mount.

Although pipes come in standard diameters, their dimensions are not always accurate. This means that an expanding band system must allow the installer to make adjustments on-site. To achieve this, the Model 6705 system is made so that general assembly can be done in the workshop, whilst adjustments can be made in the field with hand tools. An expanding turnbuckle locks the band into the pipe. To determine what installation hardware is needed for pipe installation, the pipe diameter needs to be known.

Pipe Diameter	Clamp	Bands	Joiners
Up to 600mm	6705A	6705D	-
600 - 1200mm	6705B	2 x 6705D	1
1200 - 1800mm	6705B	3 x 6705D	2

Note: Pipes less than 150mm in diameter are NOT RECOMMENDED for Starflow QSD installation due to the instrument’s size. Do the following:

1. If the inside circumference of the pipe is ACCURATELY known, then cut the band assembly to this length, LESS 25mm, for fitting clearance. Circumference (length) = Diameter x 3.14
2. Arrange the clamp, band(s) and joiner(s) so that the Starflow QSD unit will be positioned at the bottom (invert) of the pipe and an Expanding Clamp at the top (obvert) of the pipe (see diagram).

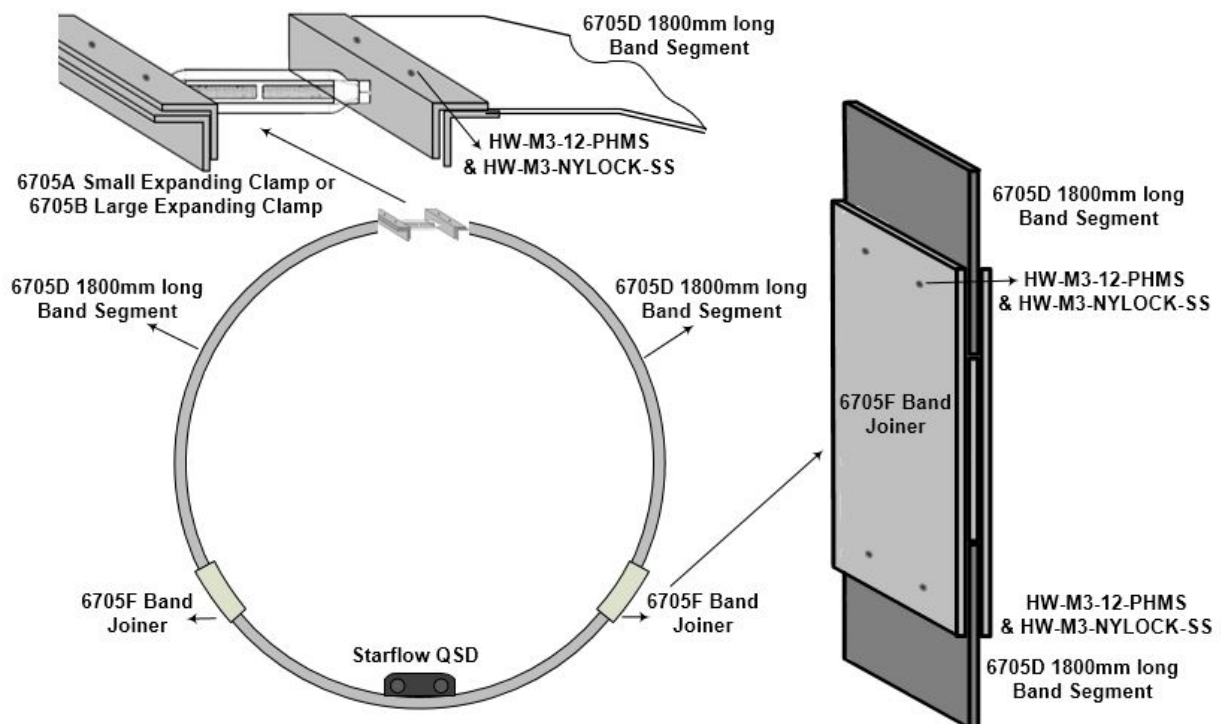

3. Drill 4 x 5mm holes, 85mm, spaced in the centre of the band to locate the instrument. Use the Starflow QSD mounting clamp 6527M as a guide.

Use a small pilot drill bit (about 2mm), then finish with the 5mm bit. When drilling stainless steel, use a slow speed and high pressure. Avoid stopping as the material will work harden, making it more difficult to drill.

4. Use M3 x 12mm stainless steel machine screws and M3 nylock nuts (supplied) to connect all parts. (If pop rivets and the pop rivet gun are available, they can be used as the replacement for the screws and nuts sets)

Note: the band length must be measured to include the Expanding Clamp (fully closed), bands and joiners altogether, as shown.

5. Position and tighten Starflow QSD and band, the bolt the Starflow QSD mount to the band.
6. Fold the band into a circle to easily fit inside the pipe and position it into place inside the pipe.
7. Slip the loose end of the band into the expanding clamp.
8. Adjust the clamp until the band is tight inside the pipe (use a spanner if necessary).

6.3. Instrument Mounting – Open Channels

Open channel installations share many of the considerations required for pipes and culvert installations.

The mounting of the instrument may be determined by the type of channel and its construction. The instrument mounting bracket should be securely affixed to the floor of the channel either directly or via an intermediary platform, such as a suitable concrete slab or a stainless-steel plate.



Where possible, the cable to the instrument should be run back behind the instrument for several meters to minimise the effect of debris caught in the cable on the measurement. Appropriate shielding or conduit should be installed to protect the cable from damage.

Care should be taken when selecting the site. Choose a location where the water flow is uninterrupted and there are no obstructions. The photo on the above right is perhaps the most ideal site with the Starflow QSD looking into the direction of flow.

It is not always possible to prepare the site, such as shown in the above photo examples. If mounting in a stream bed, look for a site free from rocks, fallen tree branches and sharp bends in the channel. Also, beware of areas where the water is turbulent and choose a site that is free from standing waves and whirlpools. These will reduce the effectiveness of the Starflow QSD and may return poor data.

If the stream bed is continually moving, there is a chance of the Instrument being covered by silt. The Starflow QSD will not work if it is covered by silt or sand. If this is a problem, then the Starflow QSD must be raised above the stream bed and a depth offset introduced.

The use of the Doppler Spectrum utility is useful when selecting a suitable site. This Doppler Spectrum utility can assist during the installation of the Starflow QSD to determine the suitability of a potential site. It can show the operator the quality of the data being returned by the instrument in Real-Time. By changing the location of the instrument, real-time information is fed back to the operator to assist in locating the instrument in the best possible location.

7. INSTRUMENT MAINTENANCE

The Starflow QSD requires very little maintenance. During routine site visits, the following checks can be performed:

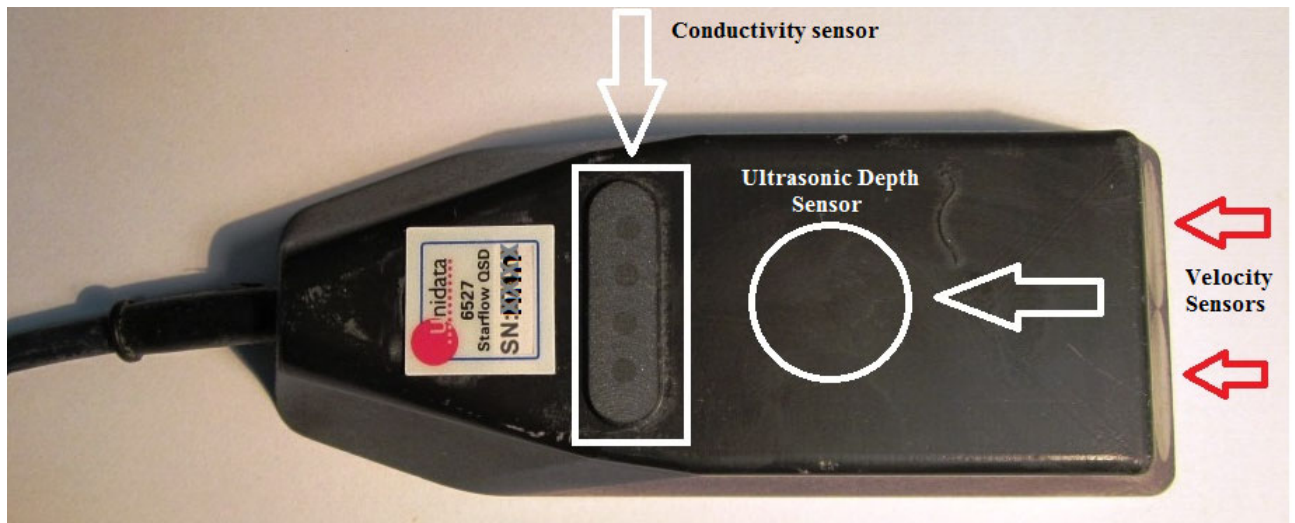

Piezo element faces

Clean the instrument surfaces where the Piezo elements are located by wiping them with a cloth. If needed, a plastic scraper can be used to remove any biofouling. Take care not to scrape the surface of the instrument. Refer to the above diagram for the areas where the ultrasonic eyes and conductivity sensors reside. These areas must be kept clean.

The front face of the instrument and the area above the depth Piezo should be clear.

Pressure depth sensor

Check that the opening to the depth pressure sensor is clear of any fouling. Use a brush to clear any material.

Conductivity Electrodes

With a cloth wipe the electrode faces. Do not use abrasive materials to clean them as this will affect the calibration of the conductivity measurement.

Cable

Inspect the cable to ensure that it has not been damaged.

General inspection

Visually check the instrument to see that it has not been damaged by heavy debris in the measured stream.

8. FACTORS AFFECTING FLOW MEASUREMENT ACCURACY

Starflow QSD measures velocity to an accuracy of $\pm 2\%$ and depth to $\pm 1\%$ of the range. This is logged to a resolution of 1 mm/sec and 1mm respectively.

The purpose of the Starflow QSD system is to produce velocity data. There are many opportunities for errors to accrue in the process and degrade the result. These can be reduced or eliminated by using the instrument properly. Some of the more significant potential error sources follow.

8.1. Alignment with Flow and Depth

For the calibration to be valid, the transducer needs to be horizontally and vertically aligned with the flow. While Starflow QSD instruments are calibrated pointing into the flow, they can be pointed downstream with little loss of calibration accuracy. You may want to do this when fouling of the sensor face is a problem. Any angled flow in the horizontal plane will reduce the recorded velocity.

The Starflow QSD instrument must be mounted in the water parallel to the surface for depth readings to measure accurately ($\sim \pm 10^\circ$), if not, the depth may read inaccurately, and therefore the recorded depth can be recorded incorrectly.

8.2. Instantaneous Versus “Averaged” Velocity

When you observe Starflow QSD velocities, they will be seen to vary by 10% or more from scan to scan at some sites. Because Starflow QSD is very sensitive to variations in velocities, you are able to see the natural velocity changes in the channel.

Although the discharge in a channel may be reasonably constant for a period of time, the velocity distribution is always changing. Different velocity streams wander from side to side and bed to surface as they progress down the channel. Turbulent swirls and eddies are carried downstream for long distances while they slowly decay. Hydrographers are used to having this action partly removed by the mechanical inertia of a current meter and the period over which a typical measurement is timed. However, all will have noticed that the rate of revolutions of the current meter varies during the timing period.

Continual velocity logging at one location with a Starflow QSD will show these cyclic velocity pulsations. The characteristics will be different for different sites and will vary with discharge. Cycles will typically include short period fluctuations (a few seconds) overlaid on longer cyclic fluctuations (up to many minutes). Longer-term pulsations may also be seen, particularly in larger streams when in flood.

When comparing Starflow QSD velocity and mechanical current meter readings, the display should be observed long enough to estimate the mean of the readings. The Starflow QSD will do most of this processing internally but, if an external logger is being used to record the readings, the averaging could also be done here. This will help attenuate short frequency variations.

8.3. Conversion of Logged to Mean Velocity

The measured velocity data may have to be adjusted during post-processing to reflect a mean velocity for the channel. The factors used will be site-specific and must be determined by the operator. This is done by obtaining a mean channel velocity by conventional techniques and comparing it with the average logged velocity. If necessary, this process should be repeated at various discharges. Where the relationship is complex or unstable, the accuracy of this method is compromised.

In laminar flow conditions, the channel mean velocity could be expected to be between 90% and 110% of the logged velocity.

In small channels (say a 500mm diameter pipe), the factor may be close to 100% as a representative area of flow will have been “seen” by Starflow QSD and contributed to the logged velocity.

In larger channels, only the area adjacent to Starflow QSD will be “seen”, and the relationship will depend on how this portion relates to the vertical and horizontal velocity distribution in the channel. An instrument located in the centre of the stream would normally be in a higher velocity area. However, in a deep channel, Starflow QSD may only see the slower portion of the velocity profile.

8.4. The Speed of Sound in Water

Velocity measurements are directly related to the speed of sound in water. The factor used to scale the velocity measurement is based on the speed of sound in freshwater at 20°C (see table below). This velocity of sound gives a calibration factor of 0.550mm/sec per Hz of Doppler shift.

This calibration factor may be adjusted for other conditions; for example, the calibration factor for seawater is 0.5618mm/sec/Hz.

The speed of sound varies significantly with water density. Water density is dependent on pressure, water temperature, salinity, and sediment content. Of these, the temperature has the most significant effect, and it is measured by the Starflow QSD and applied in the correction of velocity measurements.

The Starflow QSD corrects for the variation of the speed of sound in water due to temperature using a factor of 0.00138mm/s/Hz/°C. This correction is the best fit for water temperatures between 0°C to 30°C.

The following table shows how the speed of sound varies with temperature and between fresh and seawater.

Temperature (°C)	"Fresh Water"	"Sea Water"
0	1402	1449
5	1426	1471
10	1447	1490
15	1466	1507
20	1482	1521
25	1497	1534
30	1509	1545
35	1520	1555

The velocity of Sound in Water (m/s) at atmospheric pressure

Bubbles in the water are desirable as scatterers, but too many can affect the speed of sound. In the air, the speed of sound is about 350 m/s.

Starflow QSD Model 6527L

9. STARLOG V4 STARFLOW QSD INSTRUMENT-ONLY SOFTWARE INSTALLATION

Please follow the below procedure to install the Starlog 4, Starflow QSD Instrument only software. You must ensure you have full “Administrator Rights” to install this software package. Please consult your IT professional if you are unsure.

Use the supplied software disk along with your software key for a successful installation. The Software Key can be found on the program disk that was supplied with the Starflow QSD instrument.

A fresh copy of StarlogV4 can be obtained from the Unidata Website at the following address.

<https://www.unidata.com.au/products/datalogger-systems/datalogger-starlog-v4-software/>

If you get a fresh copy off the web, you can be sure you have the latest version of the software.

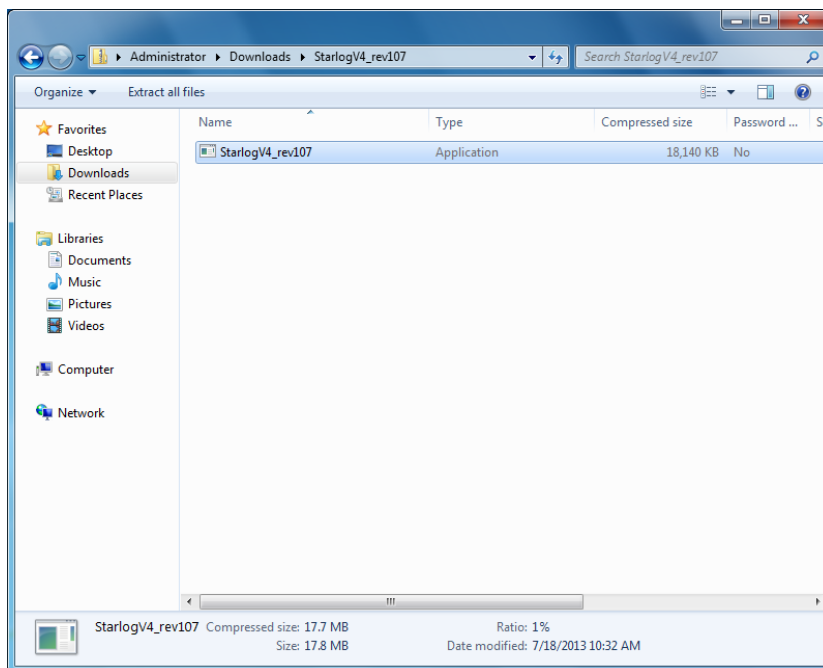

Once the download is complete, locate and run the StarlogV4.exe file. Ensure you have administrator rights before running this file.

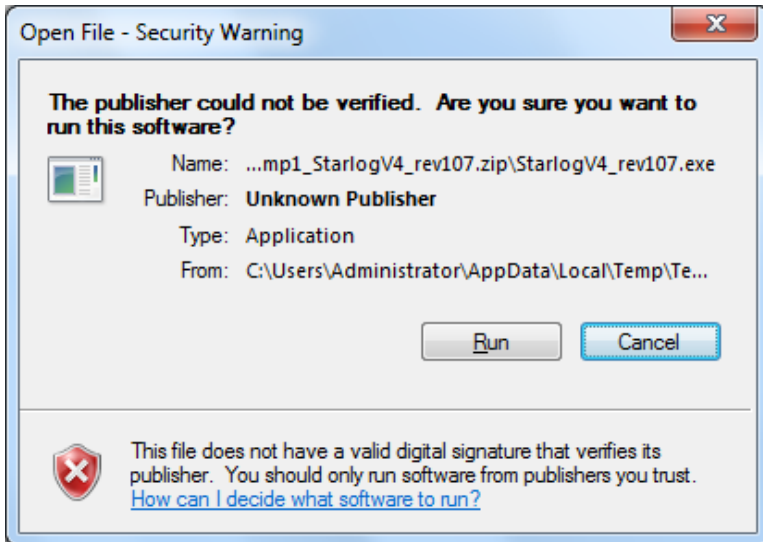

Press "Run" when you see the dialog box above.

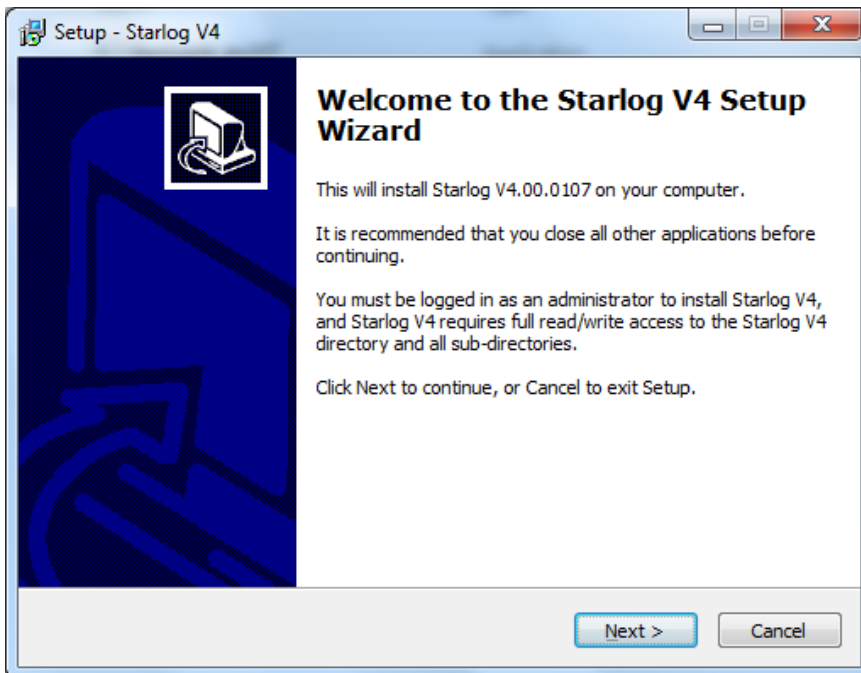

Close all other programs currently running on the computer and then press "Next".

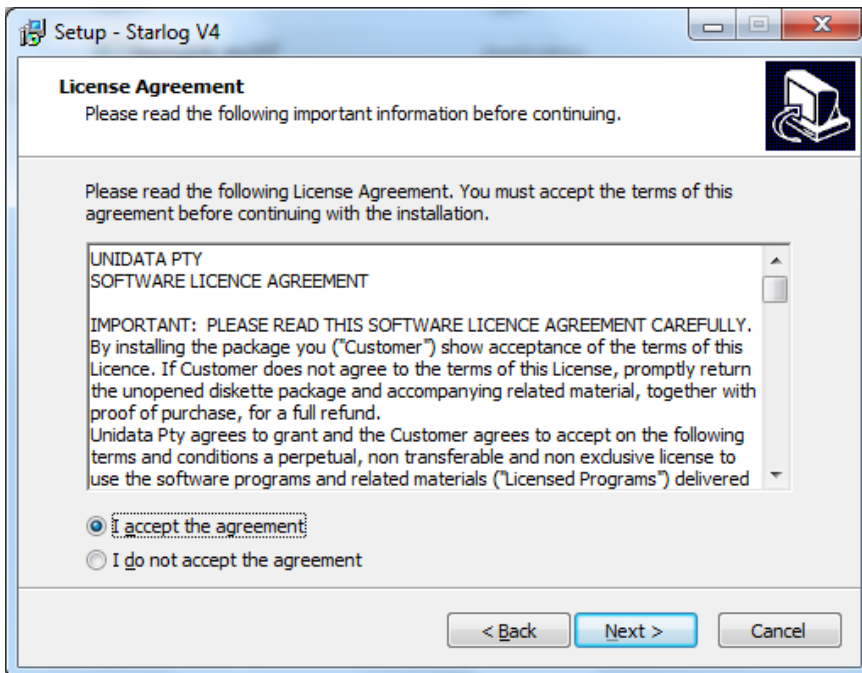

Click on “I accept the agreement” and press “Next”.

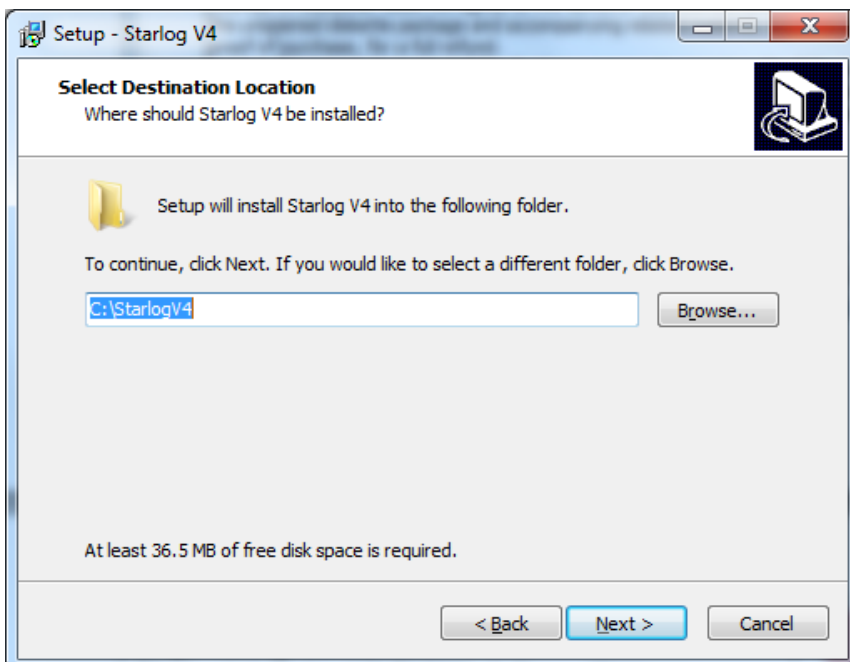

Do **NOT** change the path. StarlogV4 needs to be at this location. Do **NOT** install into the “Program Files” folder. If you do this, StarlogV4 will not run correctly!

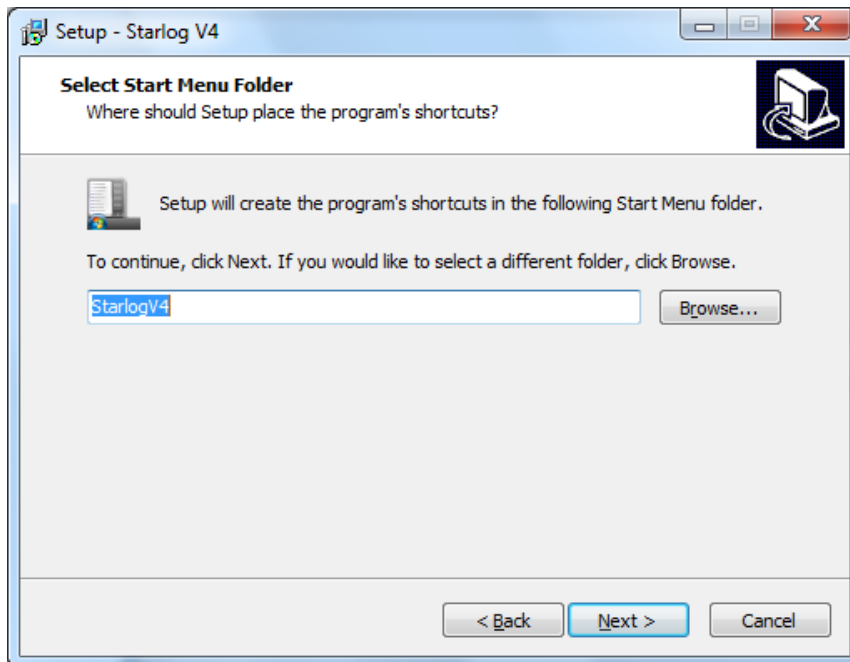

Select program shortcuts as required.

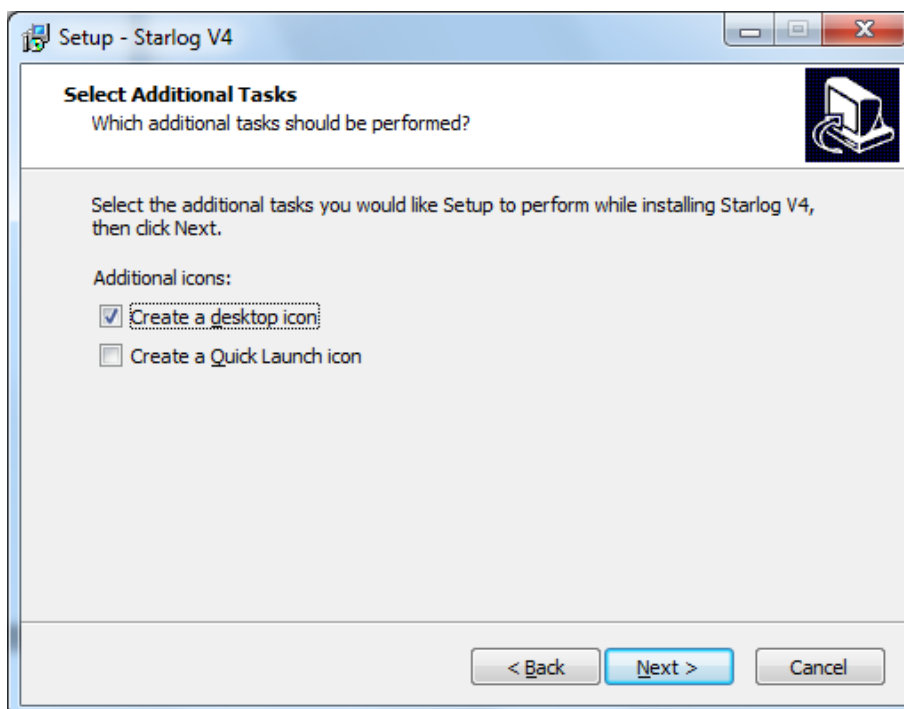

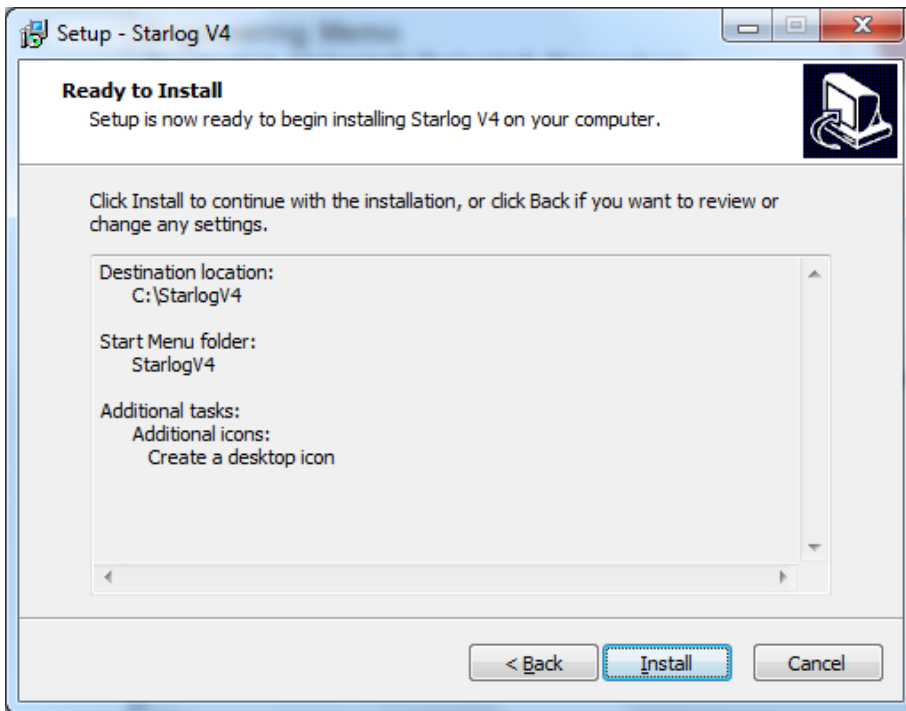

Press the “Install” button once you have selected your start icon options.

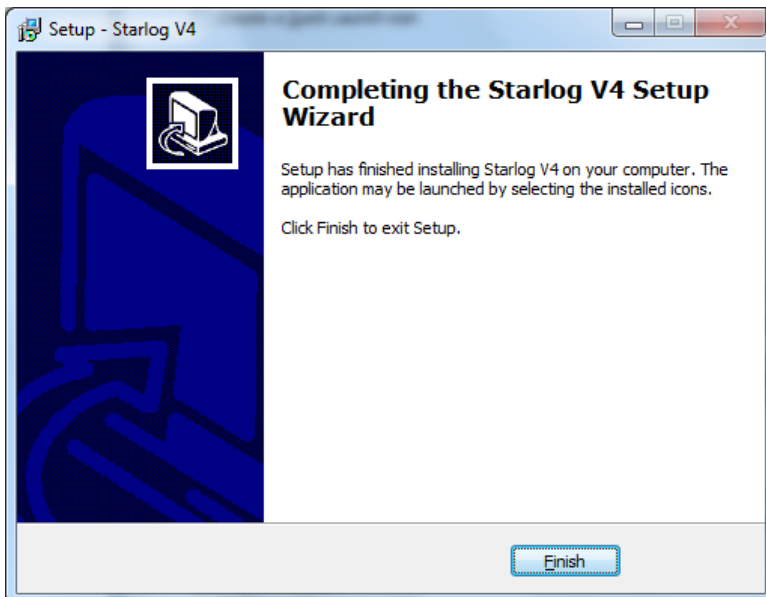

Click “Finish” once the installation has been completed.

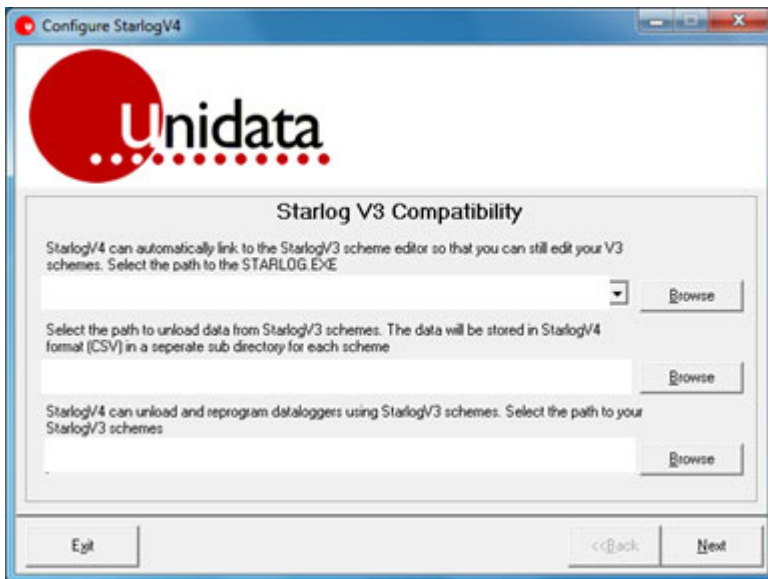

When the software is run for the first time, Starlog will ask you for the path of any Legacy Starlog Version 3 files. Leave all these blank.



This screen allows you to install one of the following:

- Starlog 4 / Starflow QSD Instrument only
- Starlog 4 / All Instruments and Loggers (Full version, additional User Name and code key required – purchased separately) – Not required if only using Starflow QSD instrument

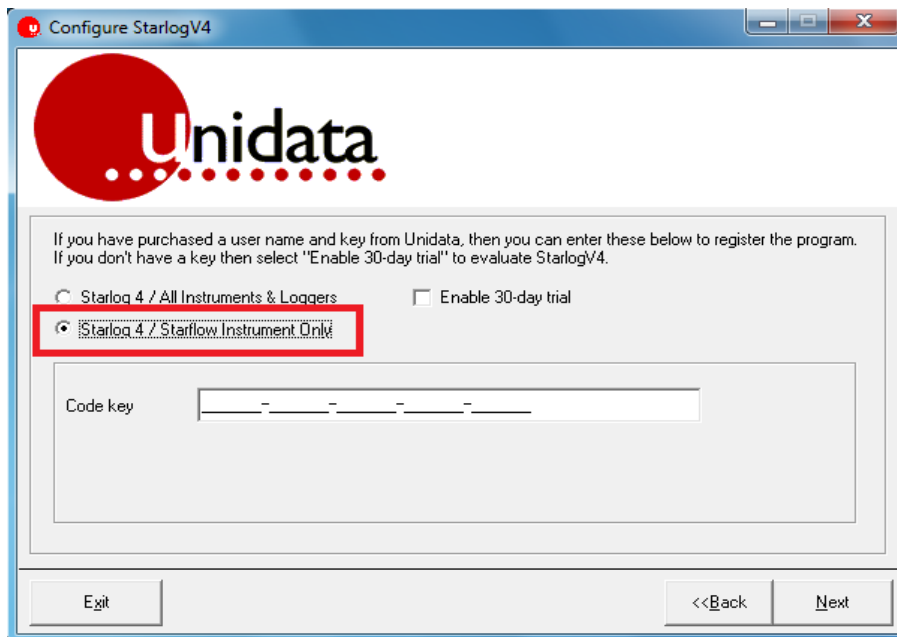

Because this installation will be for the “Starflow QSD Instrument Only” (Supplied free with the purchase of a Starflow QSD Instrument) then, you will need to select the “Starlog 4 / Starflow QSD Instrument Only” option as indicated with the red highlight above.

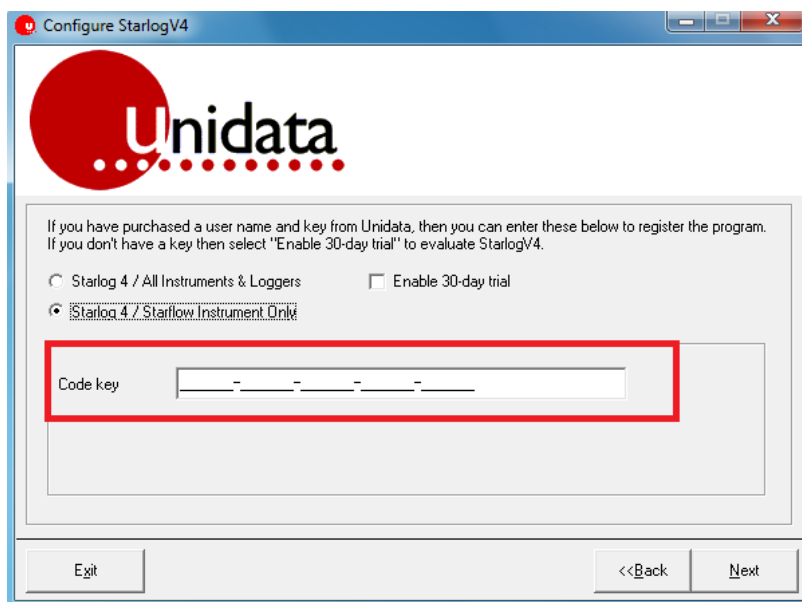

Now continue by entering your Code Key into the window. The Code Key can be located on the “Unidata Recorder Software for Starflow QSD” disk that came packaged with your Starflow QSD instrument. Press “Next” when done.

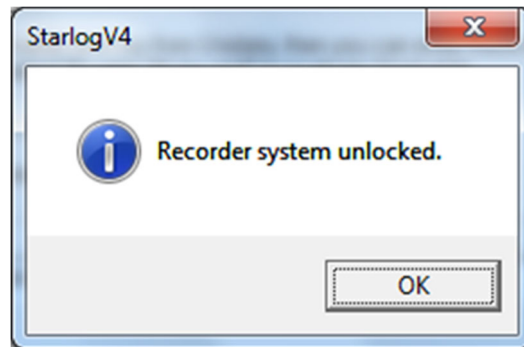

Once the Code Key has been successfully entered, you will get a confirmation window, as shown above. Press “OK”

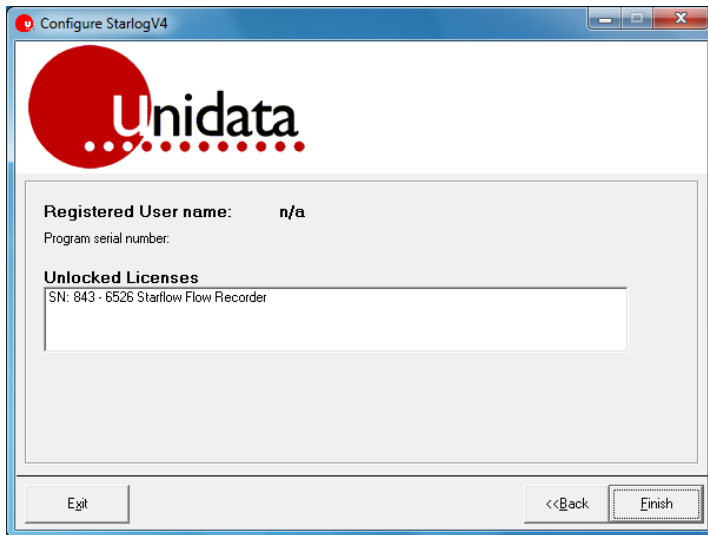

You will now see a window confirming the registration of the product and will also indicate a Software Serial No.

This completes the installation of the Starlog 4 Starflow QSD instrument only software onto your PC.

10. STARFLOW QSD SCHEME MANAGEMENT

To select an existing scheme, open StarlogV4, click on the Select icon, and created schemes will be displayed. The tabs at the top allow you to view all your version 4 schemes and all your version 3 schemes (if you have any). Select a scheme by double-clicking the link with its name.

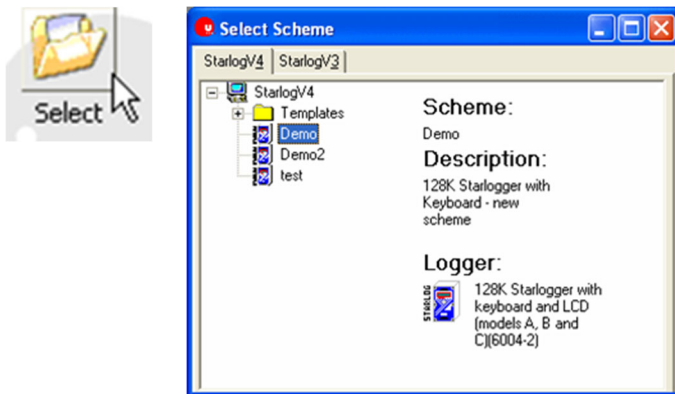

10.1. Scheme Editor

To create a scheme, you need to open the Scheme Editor. Click on the **Scheme Editor** icon in the main window.

Note: Version 4 software cannot edit version 3 schemes. You must keep a copy of version 3 software installed if you want to edit your old schemes.



When the Scheme Editor is open, select New Scheme from the File menu, or click the new icon on either of the toolbars.

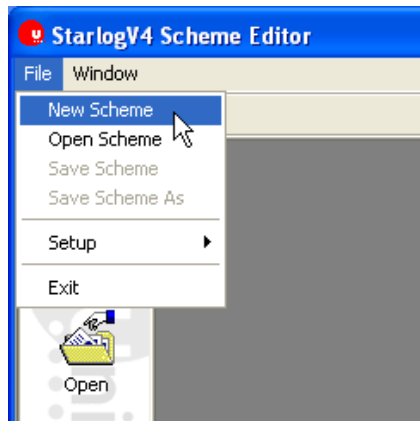
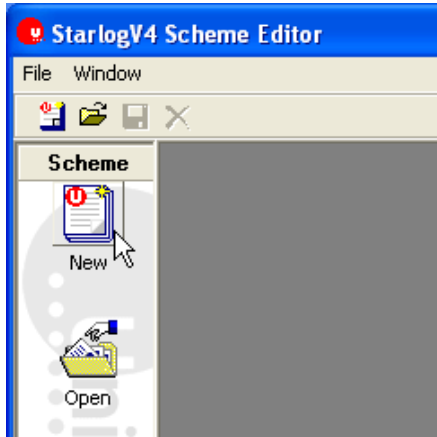

A list of data loggers will appear. Select the 6527L – Starflow QSD ultrasonic doppler velocity and depth.

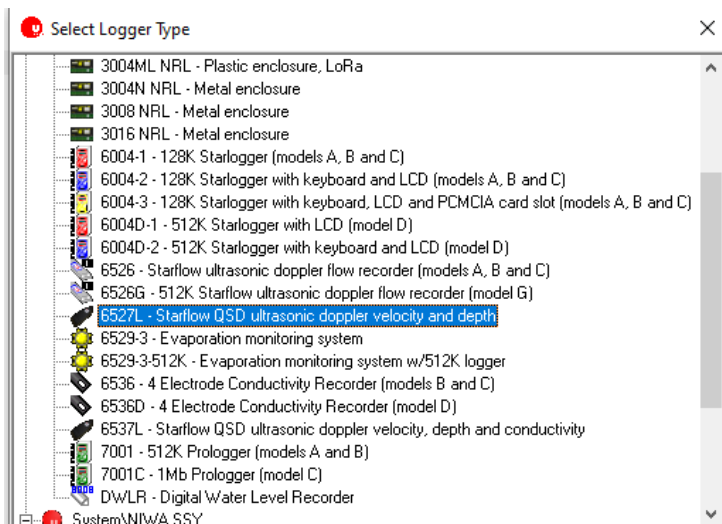

Three new icons will appear inside the left toolbar: **Settings**, **Instruments**, and **Log Buffer**

10.2. Settings

To control basic logger functionality, click on the Settings icon:

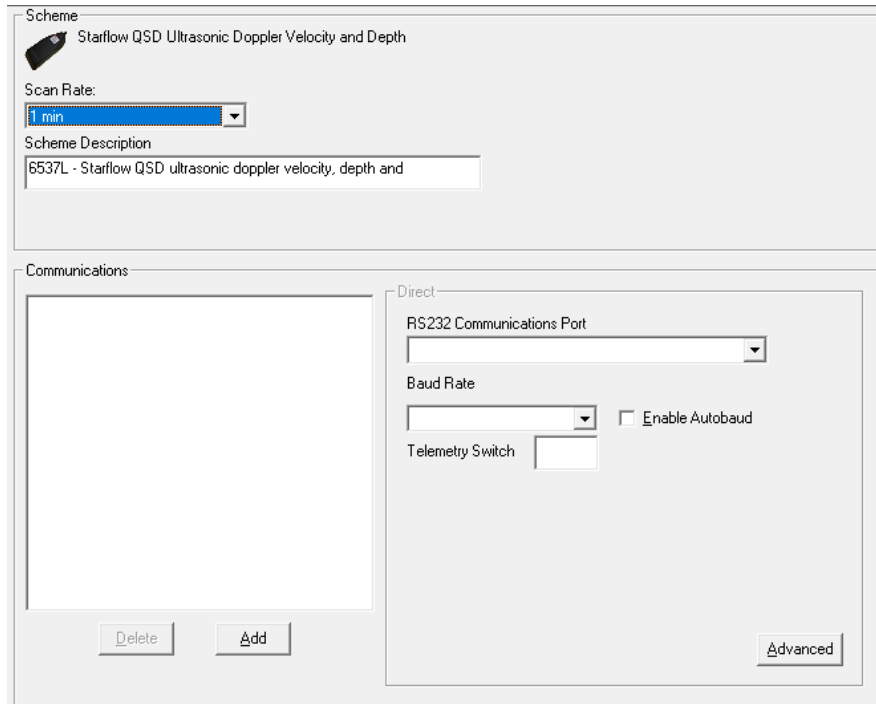

One of the most important settings is the **Scan Rate**. This defines how often the logger scans (samples) its inputs. Faster scan rates make it more likely the data logger will capture accurate minimum and maximum but will shorten the battery life.

The scan rate also influences averaging. If you want to log average data every 15 minutes, then a 5 second scan rate implies $15\text{min} \times 60\text{sec} \div 5 = 180$ samples. If you don't need that many samples, you could increase the scan rate to maximise battery life.

Another limit the scan rate imposes is on the maximum logging interval. The maximum log interval is 65535 times the scan rate. For example, if you set the scan rate to 1 second, the maximum logging interval is 65535 seconds, or 18 hours 12 minutes 15 seconds. If you want a log interval of 1 day, you will need a scan rate of at least 2 seconds.

The **Scheme Description** should be set to something that will assist you in remembering what the scheme is for.

Apart from the **Scan Rate**, the **Communication** settings are the next most critical. If they're wrong, you won't be able to program or unload your logger! The COM port can be checked in the Windows Device Manager Settings.

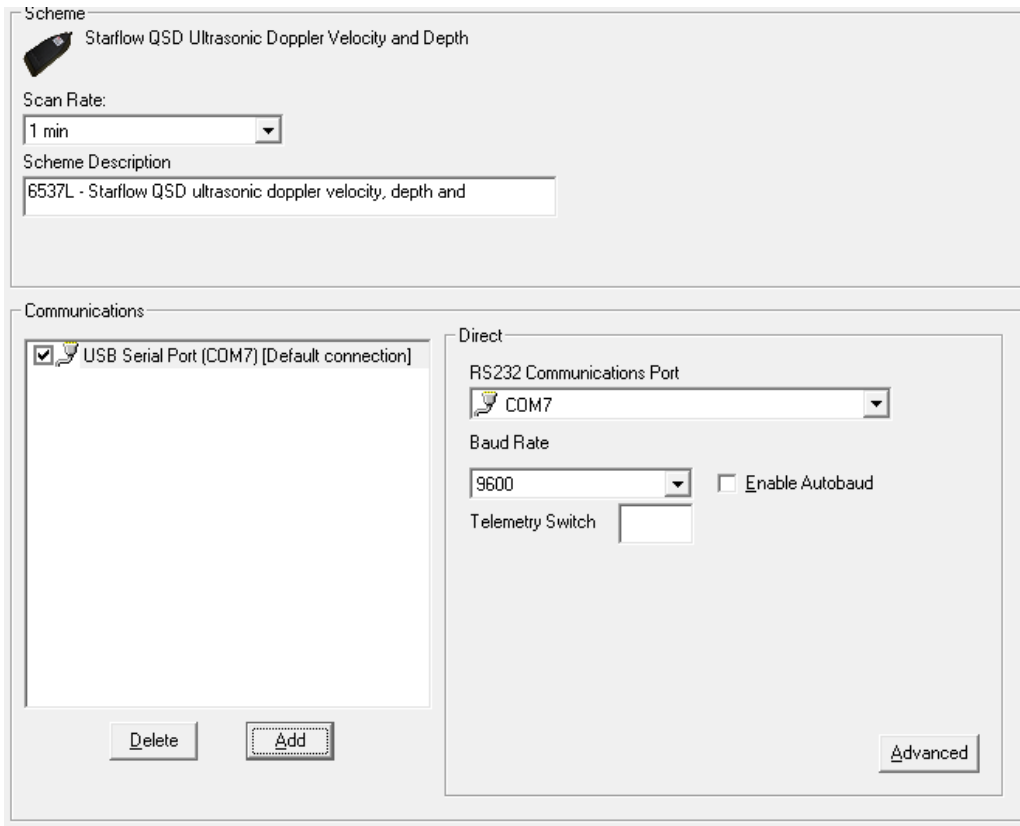

10.3. Instruments

Click on the **Instruments** icon.

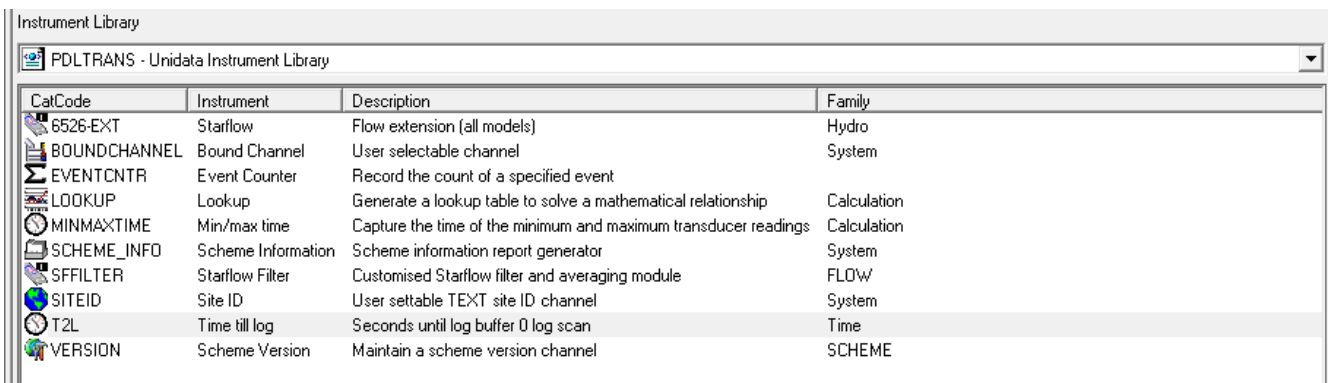

The **Instrument Library** lets you select from major groups of instruments.

When you select an Instrument Library, all the instruments in the library relevant to the selected logger are shown. The right half of the Instruments window shows the instruments that have been added to your scheme.

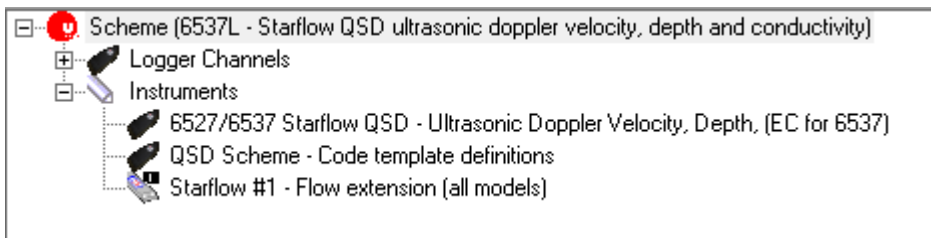

To **add an instrument** to your scheme, either double-click on its line in the left half of the window, or select it then click the **Add** button at the top of the window. A copy of the instrument will be added to the list in the right half of the window.

For example, to add the Starflow QSD LCD Module instrument to your scheme:

1. Select 6526-EXT Starflow QSD flow extension
2. Click the **Add** button to add the instrument to the scheme.

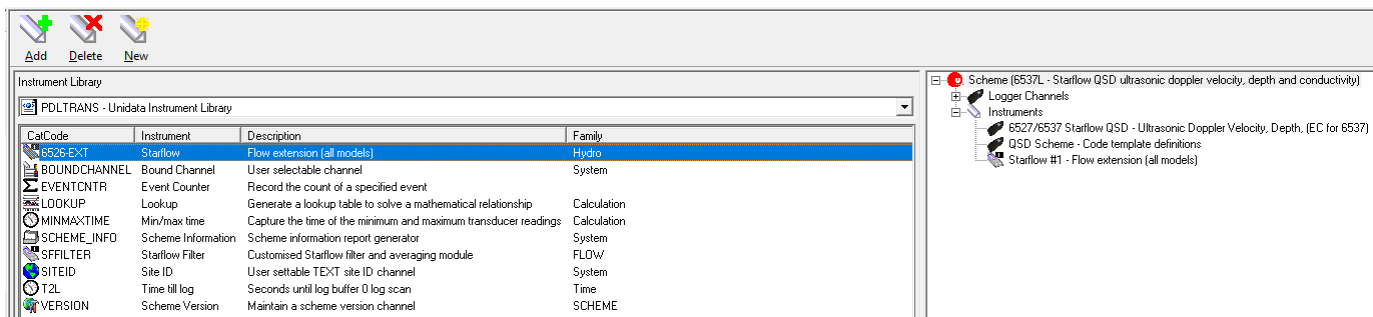

To **remove an instrument** from your scheme, select it from the list in the right half of the instrument window and click the **Delete** button at the top of the window, or right-click on it and select **Delete** from the menu.

To **configure an instrument**, double-click on its line in the right half of the window, or right-click on it and select **Edit** from the menu. Different instruments have different configuration windows and options.

10.4. Flow Measurement Extension

Starflow QSD is able to perform a wide range of flow calculations. This enables Starflow QSD to be used in partly filled circular pipes, regular open channels and natural streams. Other closed shapes such as ovoid pipes, require a user-defined Area Rating Table.

Terms

Area (A):	(Cross section) Calculated by Starflow QSD from the Area Rating Table using the measured depth. Units = cm ² or dm ² or m ² .
Area Rating Table:	A look-up table of depth versus cross-sectional area of the channel being measured.
Depth (D):	Water depth above the Starflow QSD unit. Units = mm.
Velocity (V):	The average (median) velocity of water in the channel measured by Starflow QSD. Units = mm/s.
Scan Rate (SR):	Frequency of Starflow QSD measurement cycle (Default = 60 secs). Units = second.
Log Interval:	Frequency of Starflow QSD recordings. (Default = 15 minutes). Units = scans
Flow Rate (FR):	Instantaneous Flow Rate, calculated by Starflow QSD as the product of Velocity and Area. Units = l/s or kl/s or Ml/s. <i>FR V A</i>
Flow (F):	Flow volume of each scan interval is calculated by Starflow QSD as the product of the Flow Rate and the measurement interval (Scan Rate). Units = l or kl or Ml <i>F FR SR</i>
Total Flow (TF):	Totalised Flow Volume. Units = l or kl or Ml <i>TF F</i>

When the Flow Extension is added, select the Depth and Velocity channels, noting that depending on the site, either the Ultrasonic or Pressure Depth can be chosen.

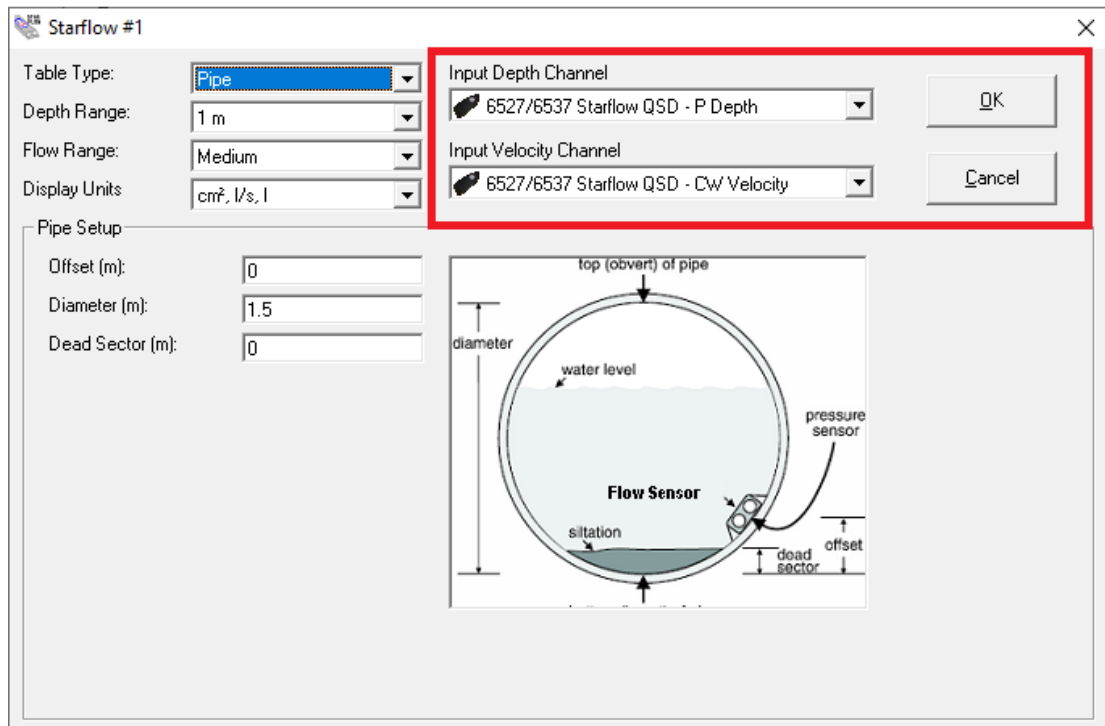

10.5. Overview of Creating a Flow Scheme

Creating a Starflow QSD Scheme for flow measurement is a five-step process:

1. Determine the dimensions of the channel.
2. For open channels, create a Cross-Sectional Area in the Flow extension instrument which has already been added in the scheme editor and enter the parameters of your channel. Points can be added and deleted, also note that the Starflow QSD range should be selected, this will be written on the front of the Starflow QSD. If your water depth will always be below 1m it is advisable to choose the 1m range.

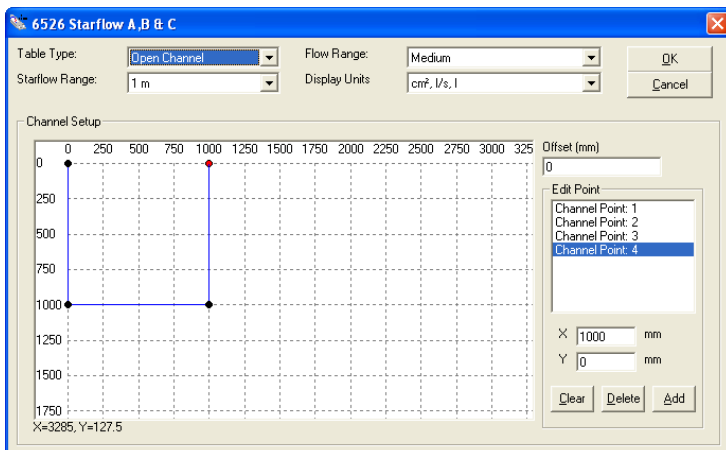

3. The table type can also be a pipe; in this situation the pipe dimensions should be entered.

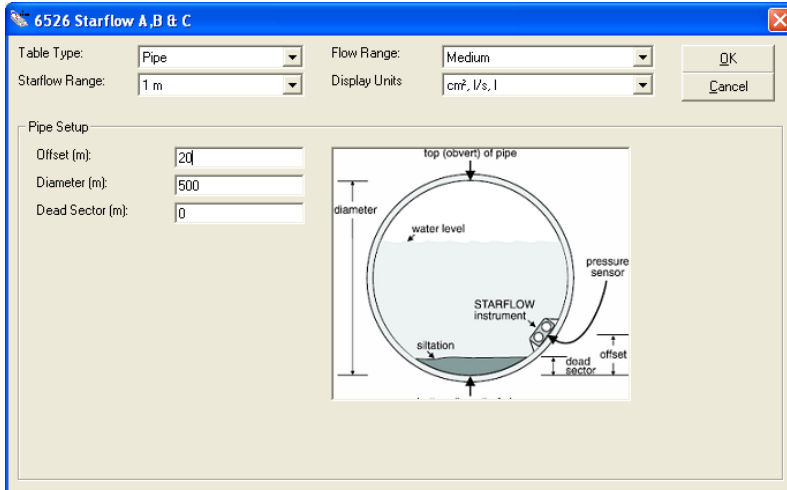

4. In the case of a User Defined Area Rating Table, select the text file to be used.

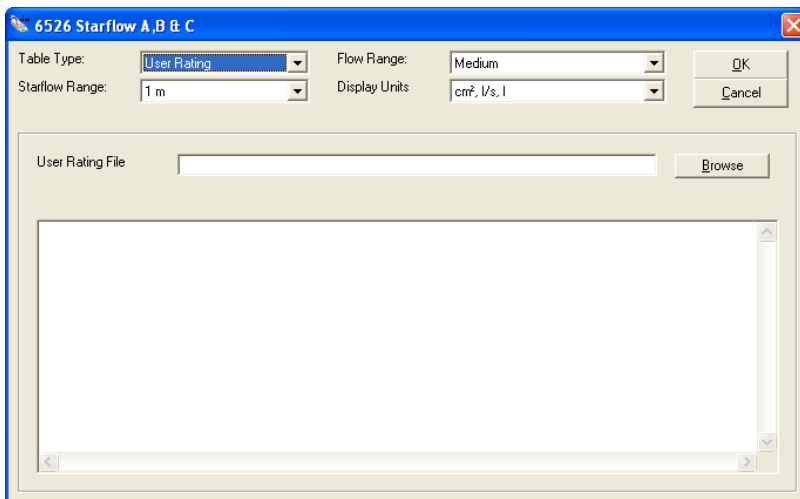

5. Once this has been completed then Save the Scheme.

10.5.1. Creating an Area Rating Table

To calculate Flow, Starflow QSD uses a lookup table called the Area Rating Table. The Area Rating Table is automatically generated when the scheme is saved from information provided in the Flow extension instrument.

An Area Rating Table is created for each scheme. This table is generated by one of three methods depending on the Starflow QSD site.

Type	Starflow QSD Site	How Created
Pipe	Partially filled circular pipe	Enter offset, diameter, and dead sector in the Area Rating Table window.
Open Channel	Open channel and natural stream	Entering the correct dimensions in the flow extension instrument
User Defined	Other closed-in shapes, like an ovoid pipe	Create a text file listing measurements. Nominate this file in the scheme's User Rating file.

10.5.2. Partially Filled Pipe

There are four parameters needed to define a pipe installation.

Range (m) Depth range of Starflow QSD. This defines the depth range able to be measured by the Starflow QSD. There are two ranges: 2m and 5m although if the depth will never be above the 1m range this should be selected for greater precision. Define the smallest maximum depth for the channel that is compatible with your Starflow QSD as this will give the best results. For example - For a 2m depth range Starflow QSD in a 900mm diameter pipe choose 1 to improve accuracy.

Offset (m) Offset defines the offset from the bottom of the pipe to the position of the Starflow QSD depth sensor. This is usually zero; however, in some installations the Starflow QSD may be located away from the bottom (to avoid silt and rubbish).

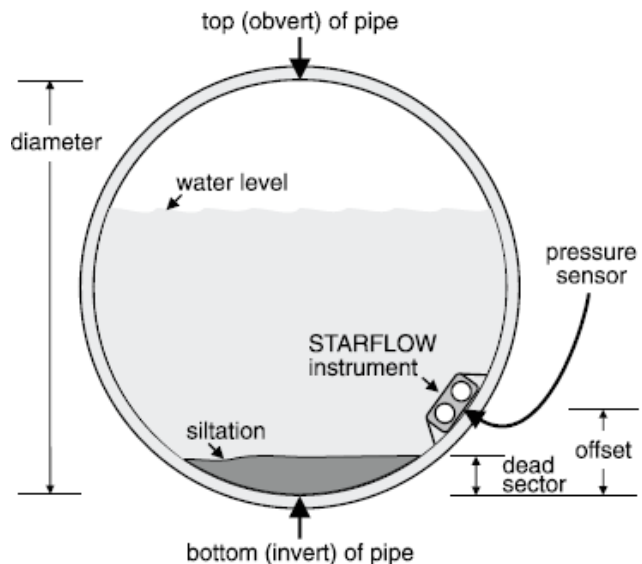

Pipe Diameter (m) Defines the pipe diameter.

Dead Sector (m) The deadband due to siltation (if any).

10.5.2.1. Pipe Example 1

The pipe is 1.8m in diameter.

A Starflow QSD unit is mounted at the bottom.

No silt (dead sector) in pipe.

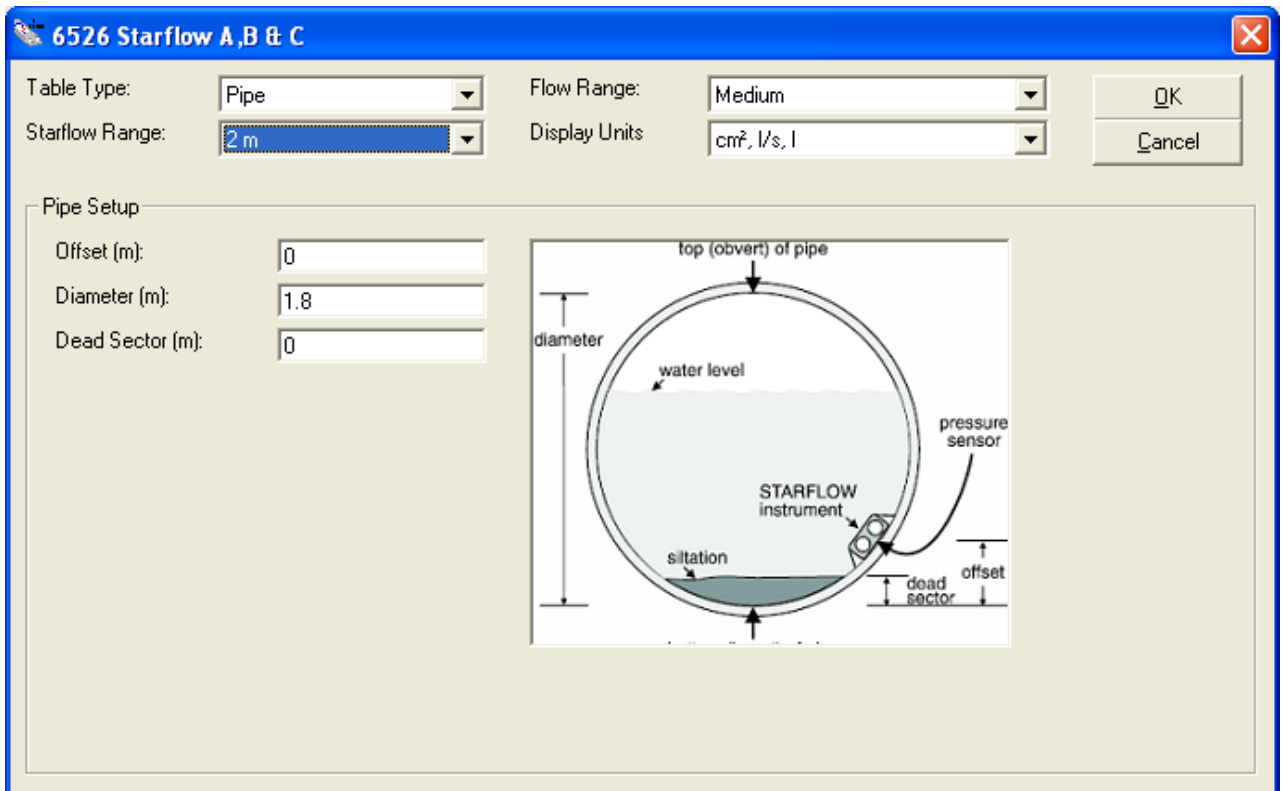
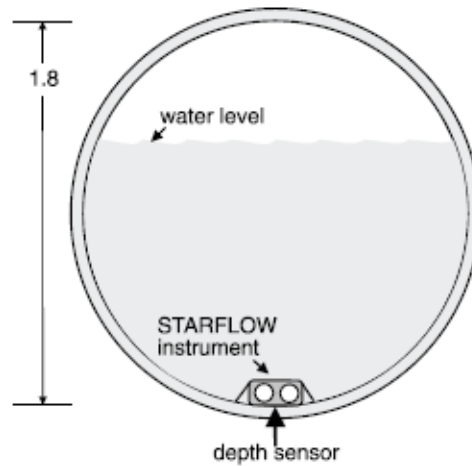

10.5.2.2. Pipe Example 2

The pipe is 900mm in diameter.

A Starflow QSD unit is mounted 100mm up from the bottom and there is 75mm of silt in the pipe.

Note that the Table Range was set to 1 to give improved accuracy. Even though using a 2m depth Starflow QSD, the maximum depth in this application is 800mm (less than 1m).

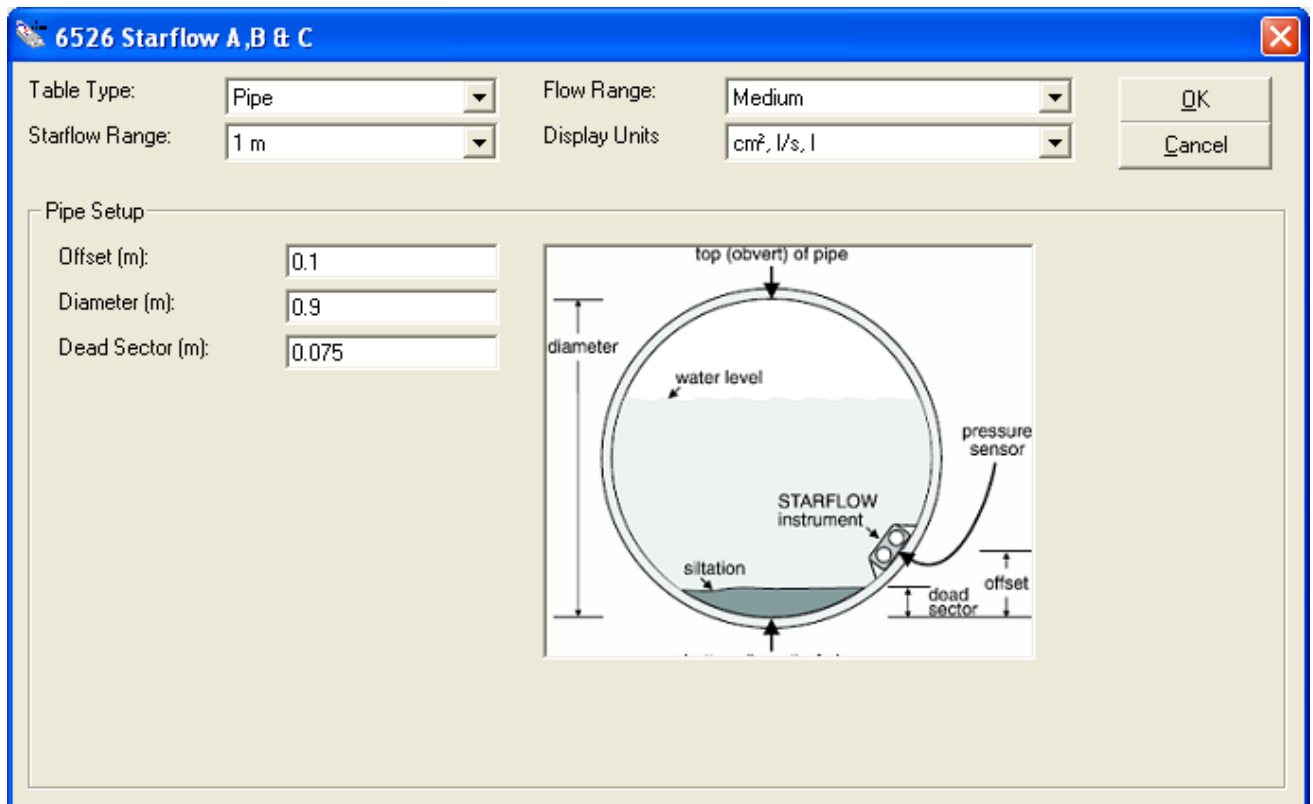
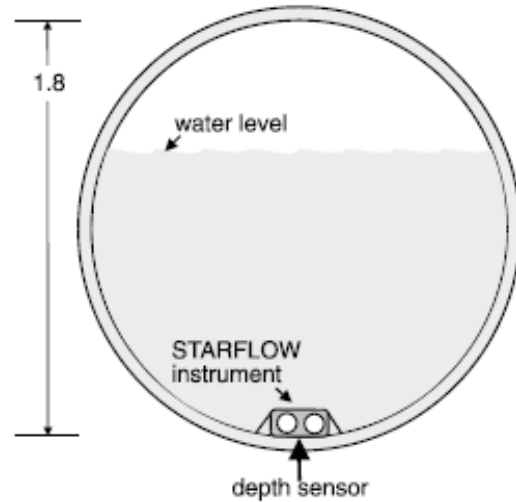

10.5.3. Open Channel and Natural Stream

The dimensional definition of any open channel (or stream) consists of pairs of “distance” and “reduced level” measurement which define the profile of the channel or stream. These pairs comprise the Channel Cross-Sectional Area.

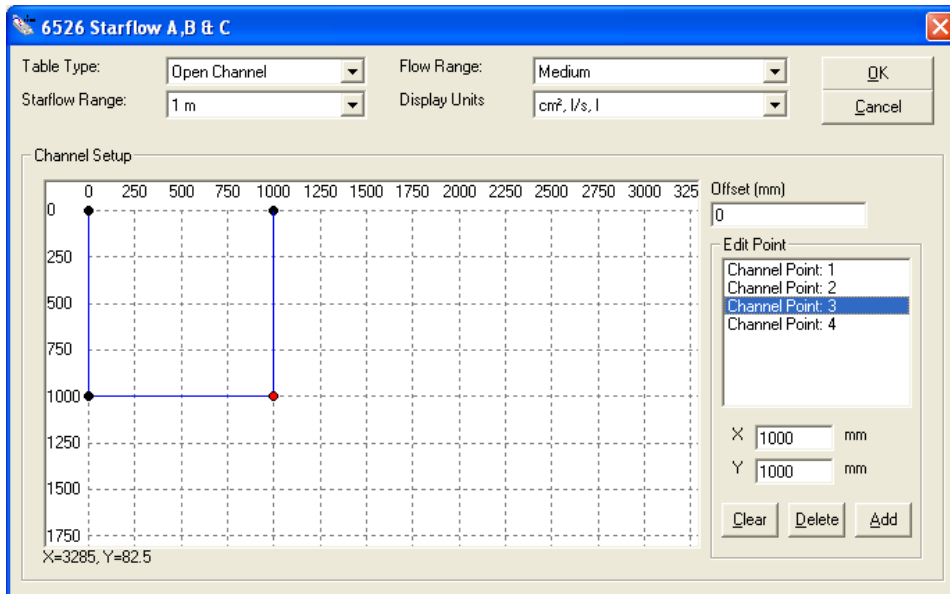

For constructed channels, this information is easily determined from known construction dimensions. For natural streams, you will need to make actual measurements of the stream bed. In addition, you require two parameters, the depth range and offset.

Range (m) Depth range of the channel. This defines the maximum depth of the channel. There are two ranges: 2m and 5m.

Define the smallest maximum depth for the channel that is compatible with your Starflow QSD as this will give the best results. For example - for a 2m depth range Starflow QSD in a 900mm maximum depth channel, choose 1 to improve accuracy.

Offset (m) This defines the offset (reduced level) of the Starflow QSD instrument from the reference to the depth sensor.

10.5.3.1. Determining Distance/Reduced Level Information

Select an arbitrary reference point above the highest water level expected. This is a (0,0) pair. Measure across the channel and down to the channel bed at a sufficient number of points to define the bed profile. Adjacent points are connected by straight lines. There may be as many Distance/RL pairs as you need.

The reference point (0,0) may be any datum standard that must be above the highest water level.

10.5.3.2. Open Channel Example 1

This Open Channel is a V-Notch shape which is 2m wide and 1.5m deep. A 2-metre depth range Starflow QSD unit is mounted at the lowest point of the notch.

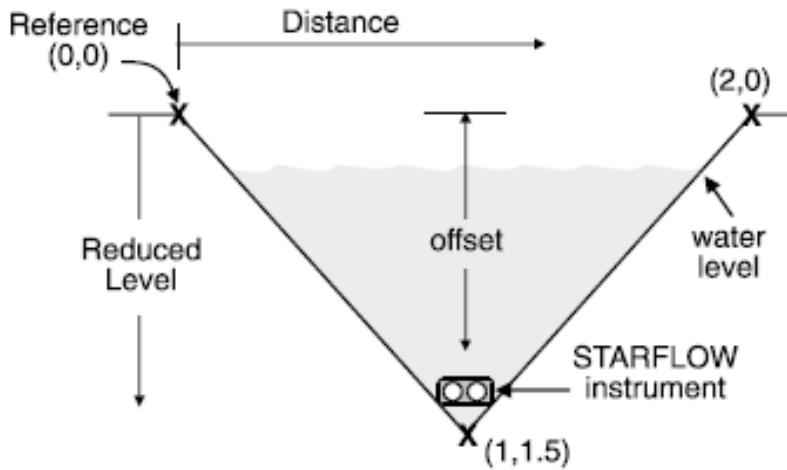

The Cross-Sectional Area File is shown below:

```
0 0
1000 1500
2000 0
```

The Area Rating Table window for this application looks like this:

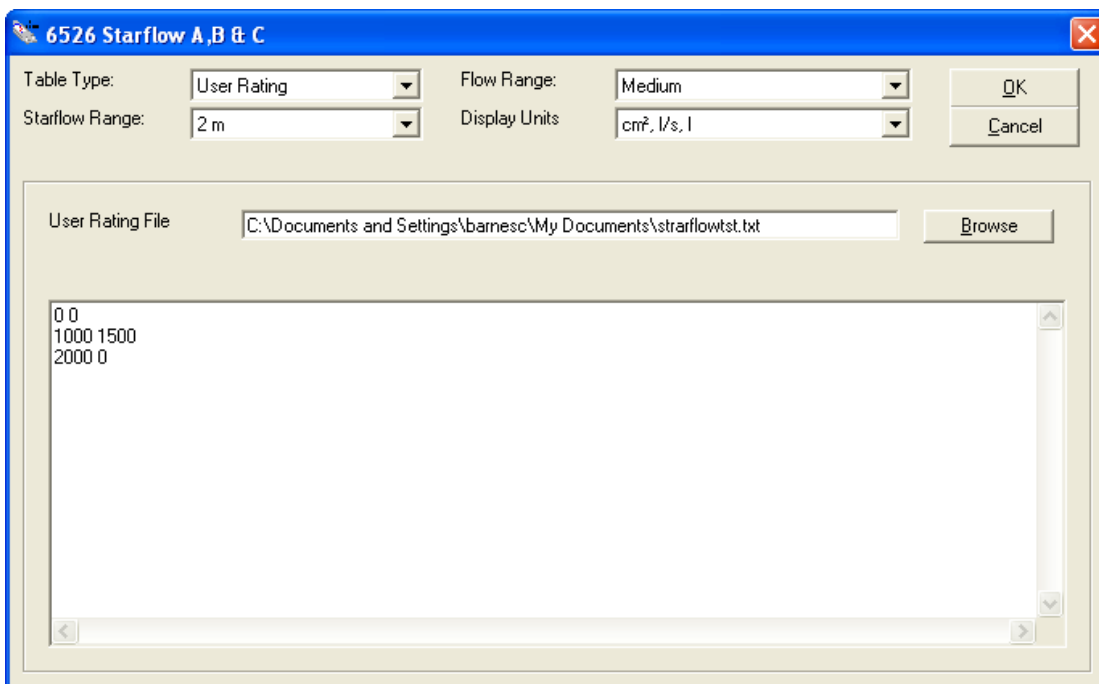

10.5.3.3. Open Channel Example 2

This Open Channel is a pre-formed two-stage Rectangular Channel which is 3 metres wide and 1m deep with a 1m x 300mm secondary channel in the centre.

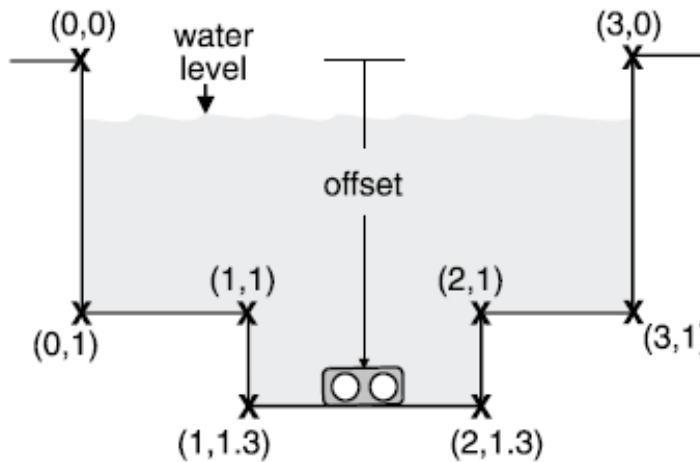

The Cross-Sectional Area File (OCEX2.XAC) is shown below:

```
0 0
0 1000
1000 1000
1000 1300
2000 1300
2000 1000
3000 1000
3000 0
```

The Area Rating Table window for this application has these settings:

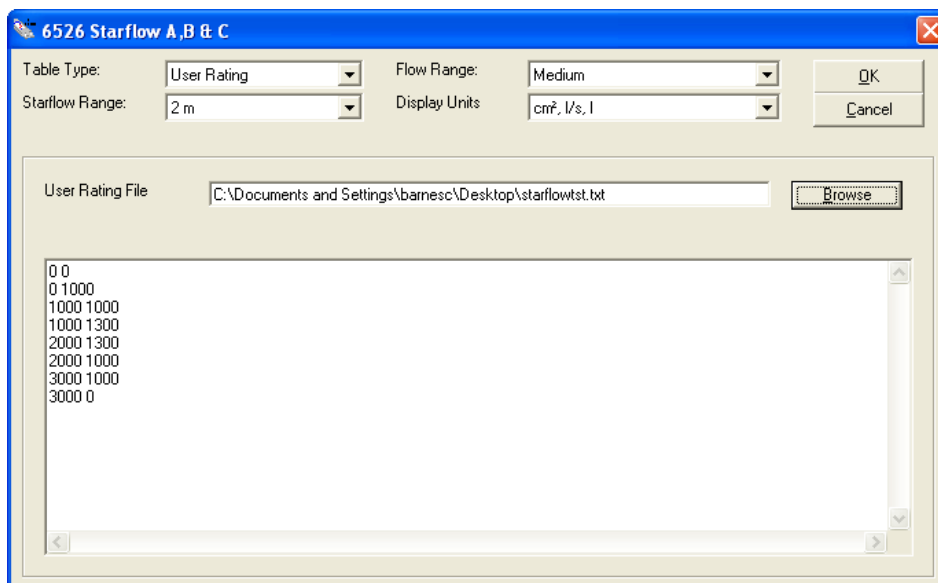

10.5.3.4. Open Channel/Natural Stream Example 3

This Natural Stream is 3 metres wide with the shape illustrated below.

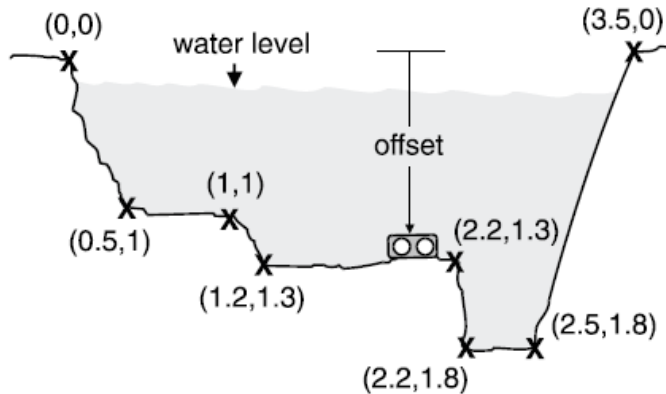

The Cross-Sectional Area File is shown below:

```

0 0
500 1000
1000 1000
1200 1300
2200 1300
2200 1800
2500 1800
3500 0
    
```

The Area Rating Table window for this application looks like this:

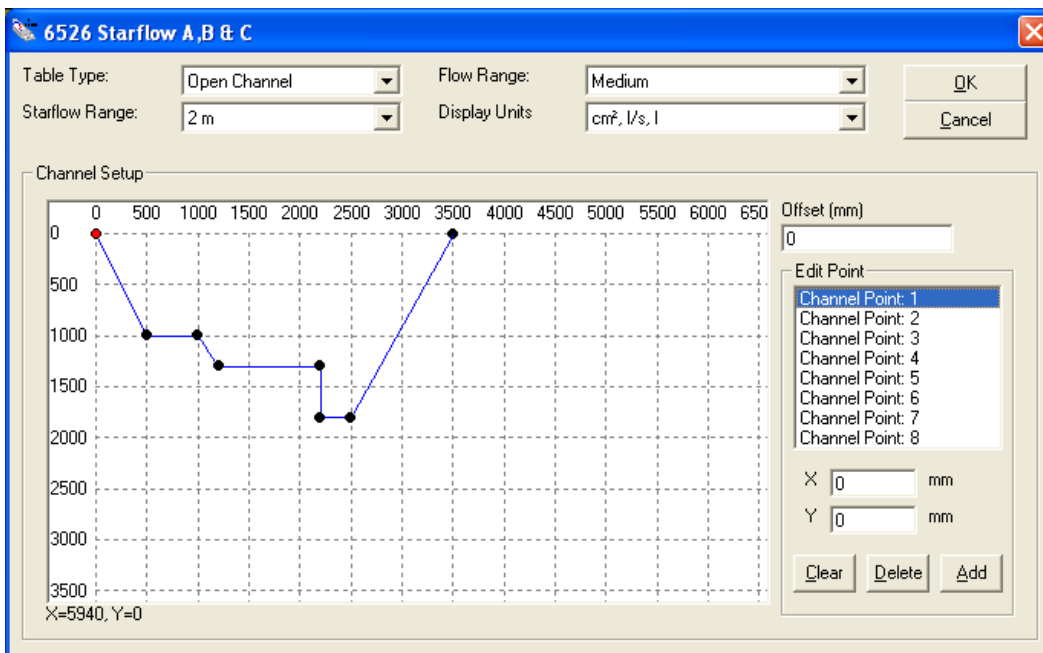

10.6. Other Applications

If the channel you are measuring cannot be defined in the Cross-Sectional Area File (such as a partly filled ovoid pipe), you must supply your own Area Rating Table. This is called a User Area Rating Table. This is only necessary if you cannot create a Cross-Sectional Area File. For most applications, the Area Rating Table is generated automatically from a Cross-Sectional Area File you create.

A User Area Rating Table is a text file with 1,000 entries spread evenly over the table range (as specified in the scheme) representing the cross-sectional area for each depth. For example, if the table range is 2m (2,000mm) then with 1,000 entries spread evenly, each entry is 2mm apart.

This table shows the depth for which each entry in the file represents an area:

Table Range	1m	2m	5m	10m
Entry 1	0 mm	0 mm	0 mm	0 mm
Entry 2	1 mm	2 mm	5 mm	10 mm
Entry 3	2 mm	4 mm	10 mm	20 mm
Entry 1000	999 mm	1998 mm	4995 mm	9990 mm

There is no special format for the file, only that each entry must be separated by whitespace (spaces, tabs, or new lines) and that there are exactly 1,000 entries. The numbers must be positive (zero or greater) and may include a fractional part. The area values are in mm².

11. CONFIGURING STARFLOW QSD

Starflow QSDs are configured just as if they were a regular instrument. When you create a scheme, an instrument for the Starflow QSD is always added as the first instrument. Double click on 6527/6537 Starflow QSD. This will then display all the Internal channels available for logging (e.g., Depth Velocity, Temperature, Battery, Spread, Samples), you will need to make sure their entries on the **Internal Channels** tab are ticked:

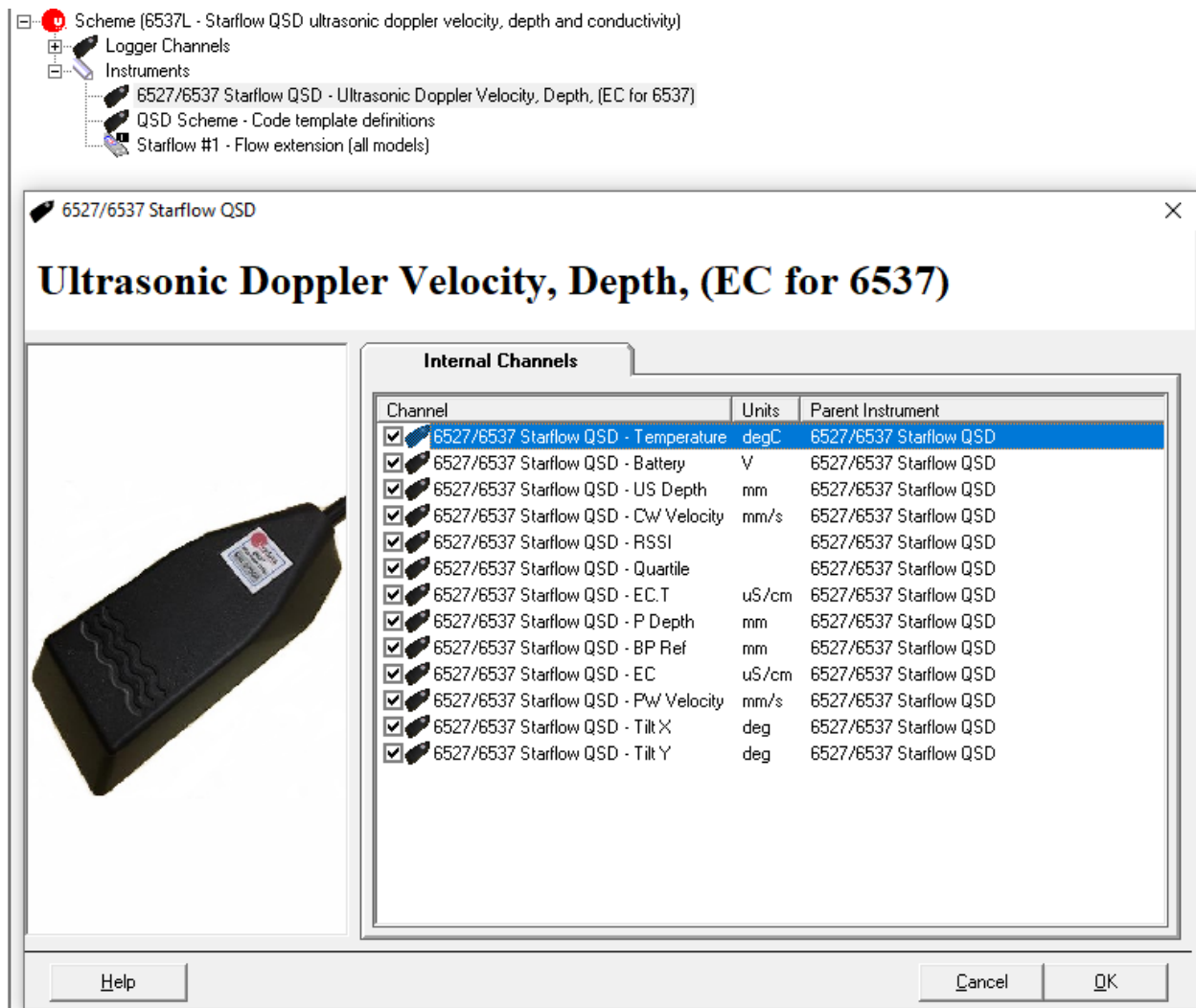

The screenshot shows a software window titled "6527/6537 Starflow QSD" with a sub-heading "Ultrasonic Doppler Velocity, Depth, (EC for 6537)". On the left side of the window is an image of the Starflow QSD instrument. On the right side, there is a tab labeled "Internal Channels" containing a table of channels. All channels in the table have a checked checkbox in the first column.

Channel	Units	Parent Instrument
<input checked="" type="checkbox"/> 6527/6537 Starflow QSD - Temperature	degC	6527/6537 Starflow QSD
<input checked="" type="checkbox"/> 6527/6537 Starflow QSD - Battery	V	6527/6537 Starflow QSD
<input checked="" type="checkbox"/> 6527/6537 Starflow QSD - US Depth	mm	6527/6537 Starflow QSD
<input checked="" type="checkbox"/> 6527/6537 Starflow QSD - CW Velocity	mm/s	6527/6537 Starflow QSD
<input checked="" type="checkbox"/> 6527/6537 Starflow QSD - RSSI		6527/6537 Starflow QSD
<input checked="" type="checkbox"/> 6527/6537 Starflow QSD - Quartile		6527/6537 Starflow QSD
<input checked="" type="checkbox"/> 6527/6537 Starflow QSD - EC.T	uS/cm	6527/6537 Starflow QSD
<input checked="" type="checkbox"/> 6527/6537 Starflow QSD - P Depth	mm	6527/6537 Starflow QSD
<input checked="" type="checkbox"/> 6527/6537 Starflow QSD - BP Ref	mm	6527/6537 Starflow QSD
<input checked="" type="checkbox"/> 6527/6537 Starflow QSD - EC	uS/cm	6527/6537 Starflow QSD
<input checked="" type="checkbox"/> 6527/6537 Starflow QSD - PW Velocity	mm/s	6527/6537 Starflow QSD
<input checked="" type="checkbox"/> 6527/6537 Starflow QSD - Tilt X	deg	6527/6537 Starflow QSD
<input checked="" type="checkbox"/> 6527/6537 Starflow QSD - Tilt Y	deg	6527/6537 Starflow QSD

Please note that Starflow QSD is not a “plug and play” type of instrument.

To get the most accurate and reliable information relevant to your installation, you will need, in a way, to “calibrate” Starflow QSD. That’s why it is always recommended that initially, Frequency, Spread, Samples and Signal are ticked in the internal channels TAB. This selection will slightly increase power consumption, but it will provide valuable information for

the “calibration” of the Starflow QSD. Later, when all parameters are set accurately these channels can be unselected.

11.1. Configuring the Starflow QSD as an SDI-12 Sensor

When the Starflow QSD is an SDI-12 sensor, other SDI-12 recorders can access, and log data sensed by it. This can be useful if you have something with a limited number of inputs, such as a Starflow QSD, but would prefer to have all data at a site logged by a single logger. You could configure the Starflow QSD as an SDI-12 sensor and use a Neon Remote Logger (IP logger) as an SDI-12 recorder to log the depth/velocity/flow from the Starflow QSD, as well as whatever other instruments you have (e.g., wind speed/direction, air temperature, rainfall).

To set a Starflow QSD as an SDI-12 sensor as well as a logger:

1. Click on the Sonic Icon

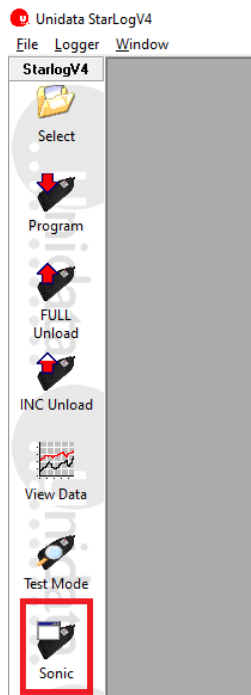

2. When the SONIC window appears click on the Connect button

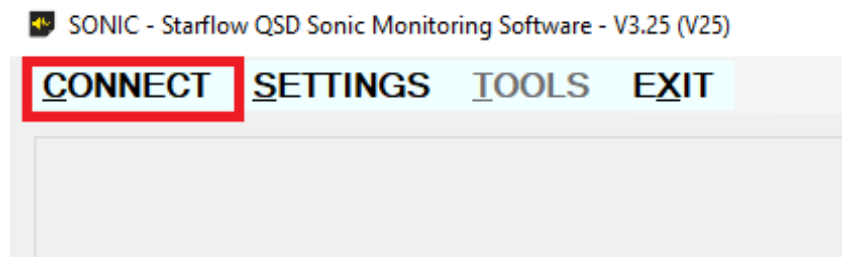

- When connected Click on Settings and then Configure QSD

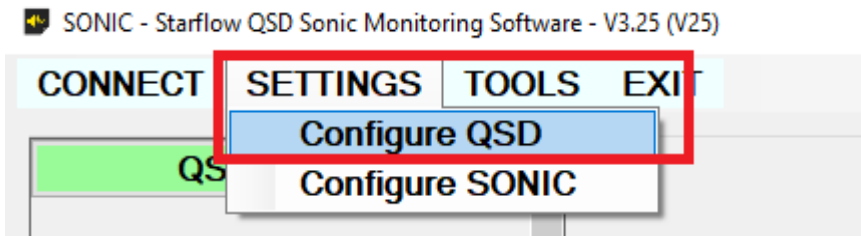

- Click on the Configure SDI-12 button

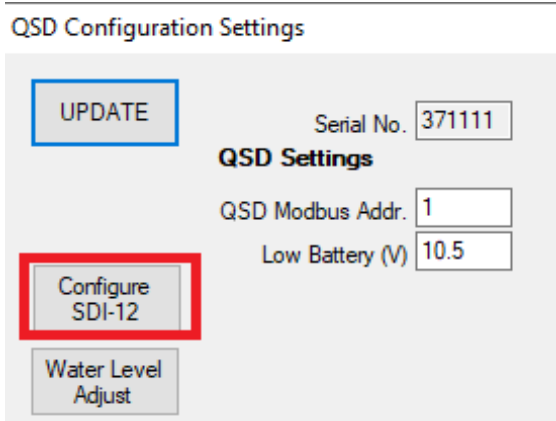

- Using the dropdown buttons select which channels you would like to configure for SDI-12 output, these can be internal channels (indicated by Q at the beginning of channel name) or logged data channels (indicated by L at the beginning of channel name). Click save once configured.

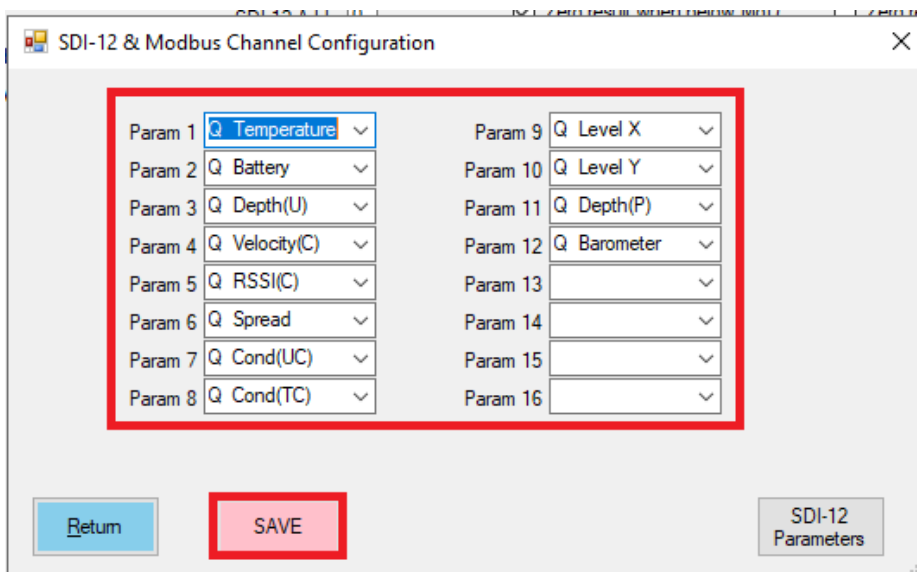

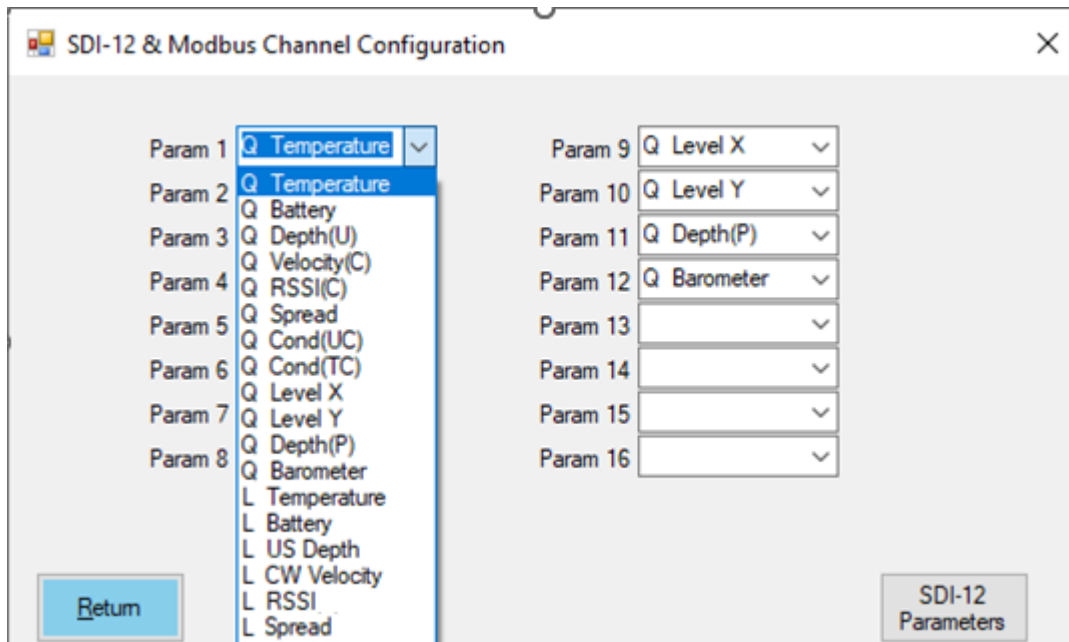

Note: Most SDI-12 outputs are 16 bit Integers and Larger Flow parameters (Flow Rate, Flow and Total Flow) are configured as a 32 bit integer, the Flow Rate will require a multiplier of 0.001, and other flow parameters have a multiplier of 1.

All other parameter definitions can be referred to in [section 5.1.1](#).

6. Click the Return button and then Exit.

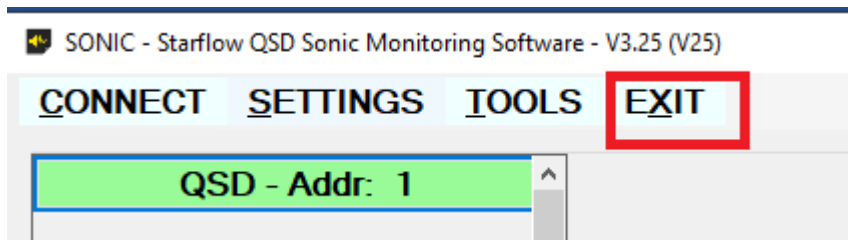

11.2. Configuring the Starflow QSD for Modbus RTU

When the Starflow QSD is a Modbus sensor, other Modbus recorders or PLCs can access, and log data sensed by it. This can be useful if you have something with a limited number of inputs, such as a Starflow QSD, but would prefer to have all data at a site logged by a single logger or PLC. You could configure the Starflow QSD as a Modbus sensor and use a Neon Remote Logger (IP logger) as a Modbus recorder to log the depth/velocity/flow from the Starflow QSD, as well as whatever other instruments you have (e.g., wind speed/direction, air temperature, rainfall).

To set a Starflow QSD as a Modbus sensor as well as a logger:

1. Click on the Sonic Icon

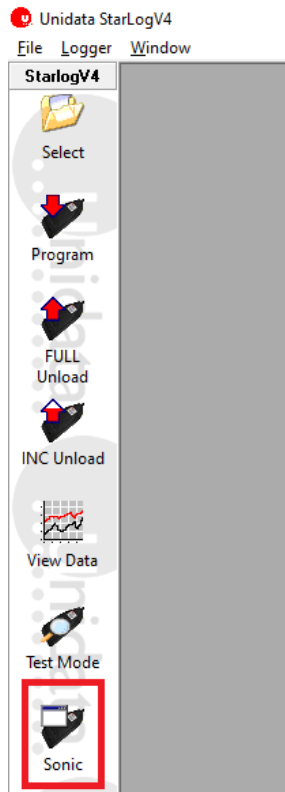

2. When the SONIC window appears click on the Connect button.

SONIC - Starflow QSD Sonic Monitoring Software - V3.25 (V25)

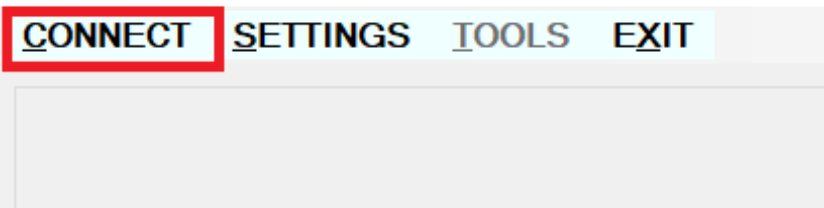

3. When connected Click on Settings and then Configure QSD.

SONIC - Starflow QSD Sonic Monitoring Software - V3.25 (V25)

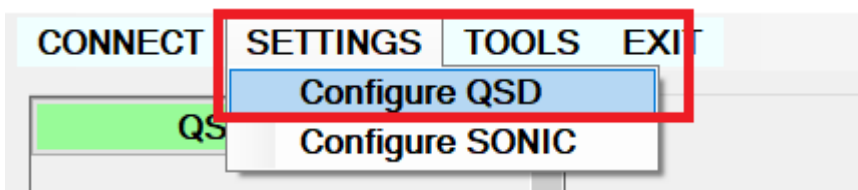

- Click on the Configure SDI-12 button.

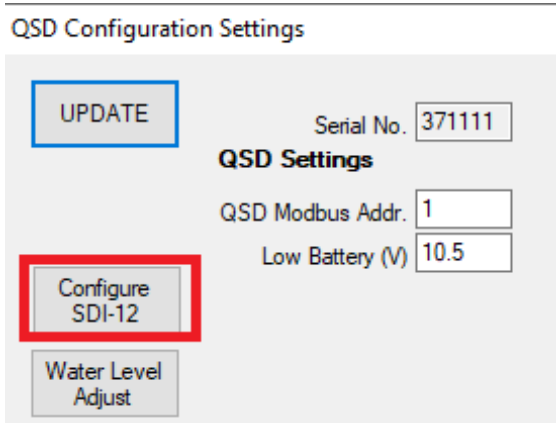

- Click on the SDI-12 parameters button.

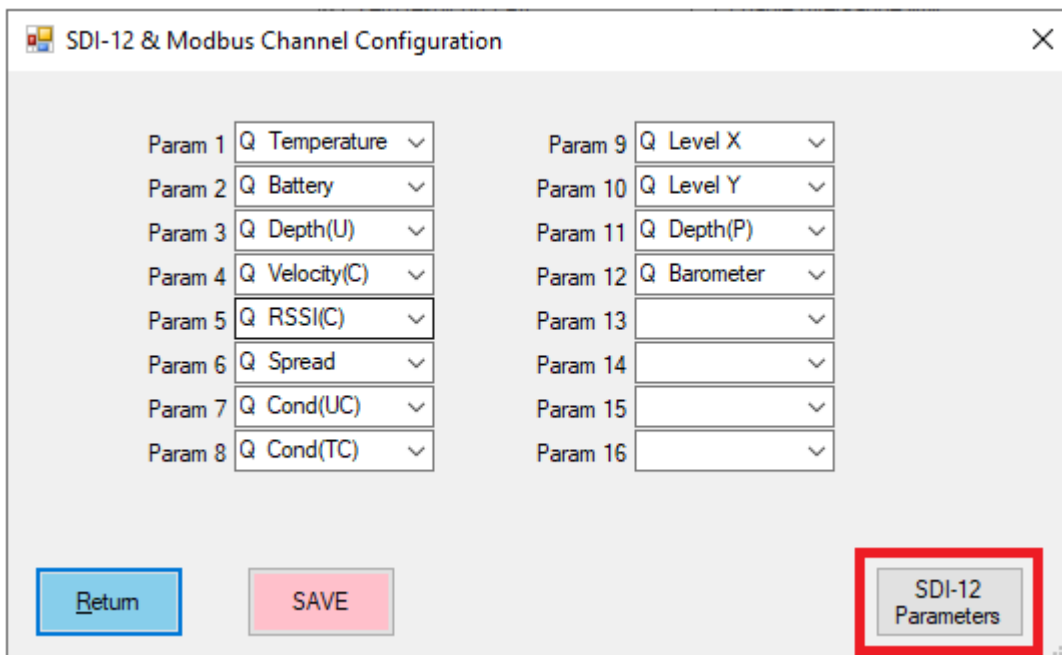

- Using the dropdown buttons select which channels you would like to configure for Modbus output, these can be internal channels (indicated by Q at the beginning of channel name) or logged data channels (indicated by L at the beginning of channel name). Click save once configured.

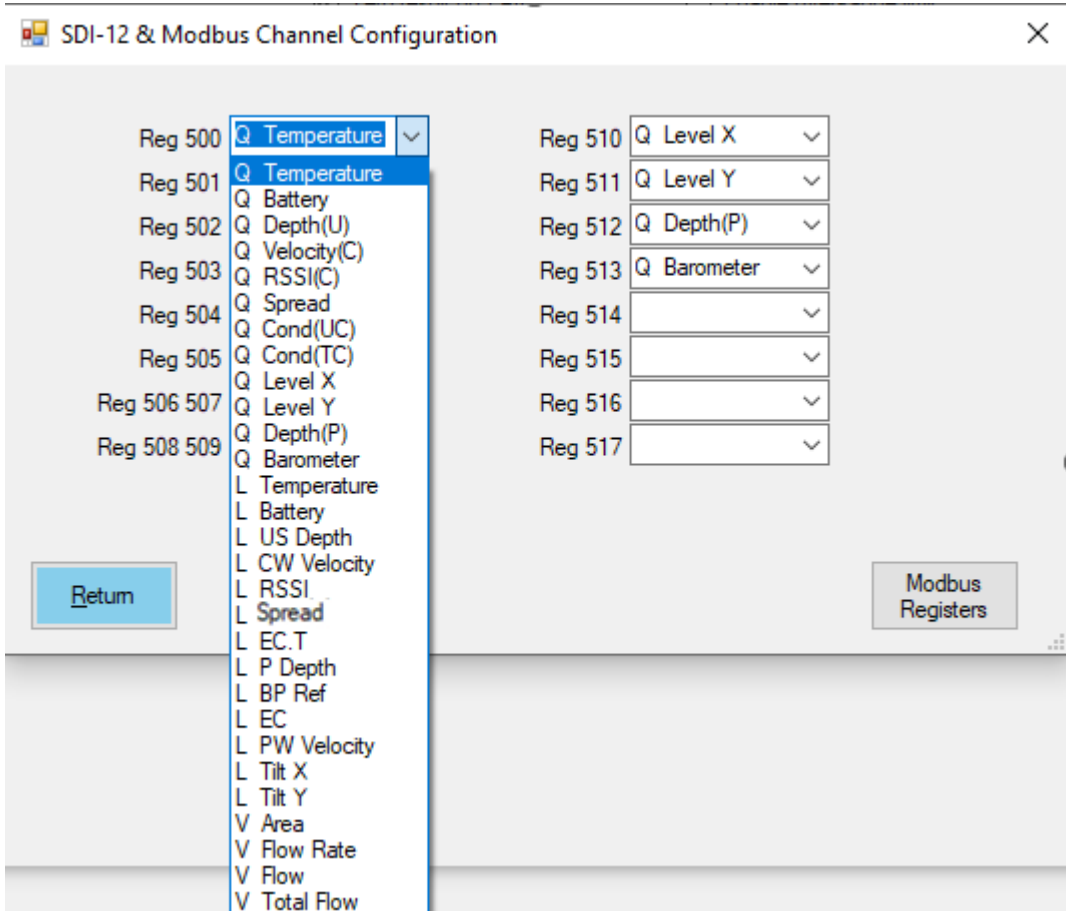
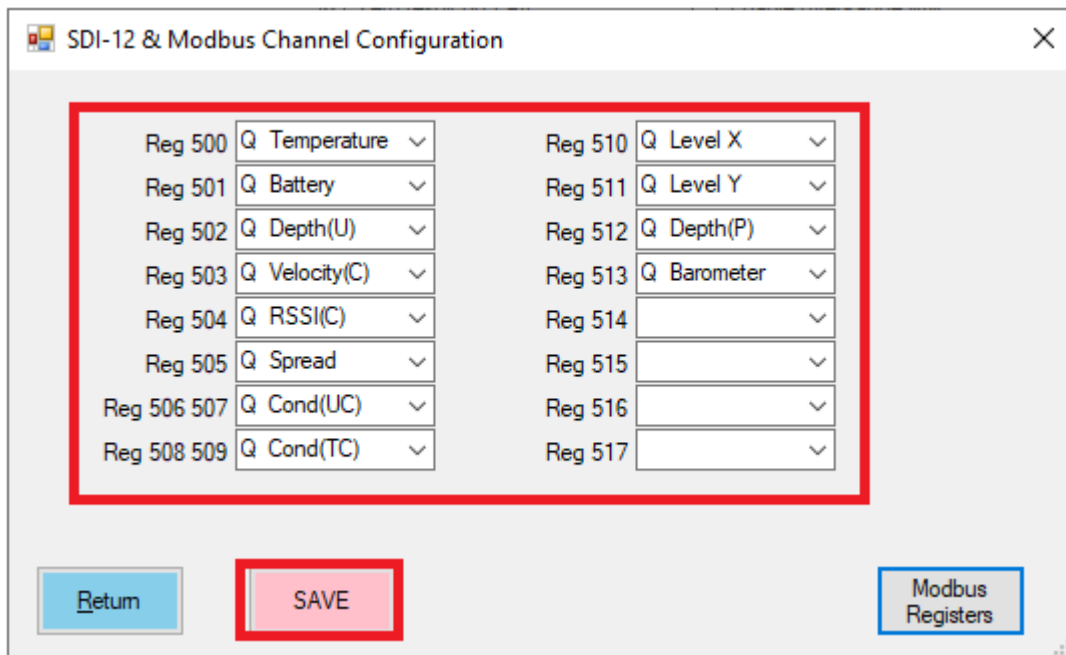

Note: Most Modbus outputs are 16 bit Integers except for Larger Flow parameters (Flow Rate, Flow and Total Flow) are configured as a 32 bit integer, the Flow Rate will also require a multiplier of 0.001, and other flow parameters have a multiplier of 1.

All other parameter definitions can be referred to in [section 5.1.1](#).

An example below shows where the Modbus registers for 32-bit integers is shown as two registers.

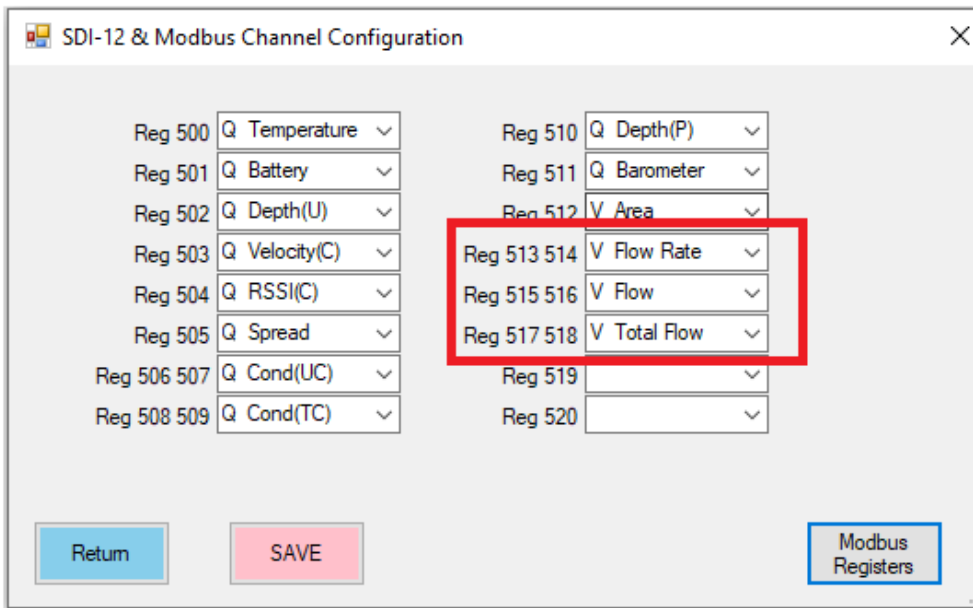

Area (RAW) cm ²	Area (AVG) cm ²	Flow Rate (RAW) l/s	Flow Rate (AVG) l/s	Flow (RAW) l	Flow (AVG) Total l
:050	4050	0.000	0.000	0	0
:050	4050	0.000	0.000	0	0
:050	4050	0.000	0.000	0	0
:050	4055	0.000	0.000	0	0
:050	4051	0.000	0.000	0	0
:050	4050	0.000	0.000	0	0
:930	4030	69.168	47.168	692	471
:080	4003	71.808	70.458	718	704
:080	4080	71.808	71.808	718	718



Alias	4x0510
1	
2	
3	
4	71808
5	
6	718

7. Click Return button and then Exit.

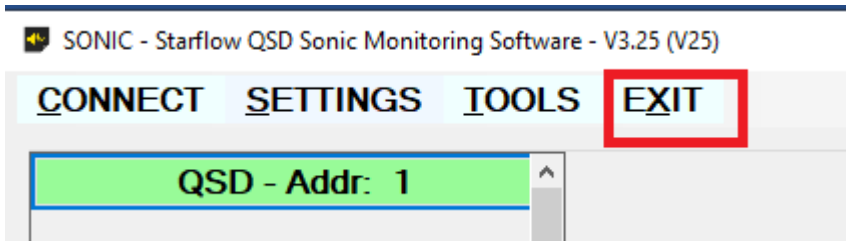

11.3. Configuring Starflow QSD Settings

The Starflow QSD Settings allows the user to modify the operation of the Starflow QSD, it contains very important factors which are used to interpret the Starflow QSD data. To see these options, use the following steps:

Click on the Sonic Icon.

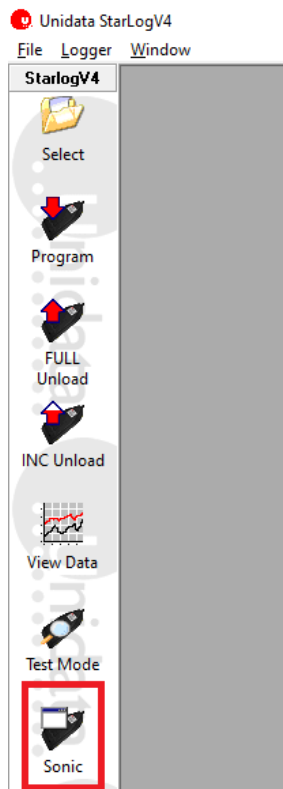

1. When the SONIC window appears click on the Connect button.

SONIC - Starflow QSD Sonic Monitoring Software - V3.25 (V25)

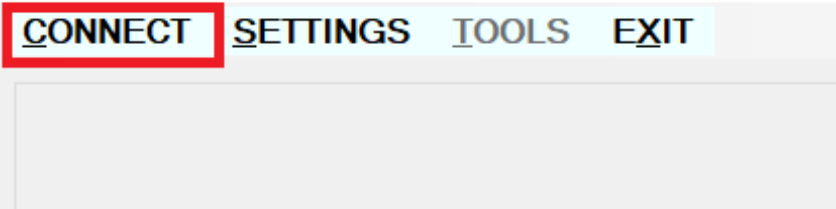

2. When connected Click on Settings and then Configure QSD.

SONIC - Starflow QSD Sonic Monitoring Software - V3.25 (V25)

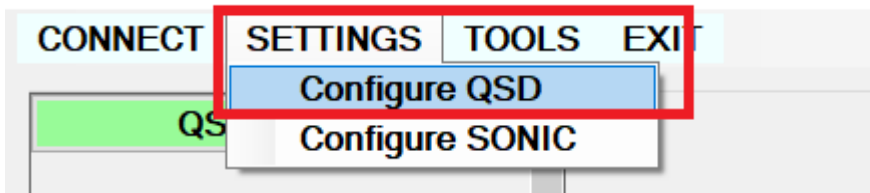

QSD Configuration Settings

<p>UPDATE</p> <p>Serial No. <input type="text"/></p> <p>QSD Settings</p> <p>QSD Modbus Addr. <input type="text" value="1"/></p> <p>Low Battery (V) <input type="text" value="10.5"/></p> <p>Configure SDI-12</p> <p>Water Level Adjust</p> <p>Restore from Factory</p> <p>Return</p>	<p>SDI-12 Settings</p> <p>SDI-12 Addr. <input type="text" value="0"/></p>	<p>U.Sonic DEPTH Settings</p> <p><input checked="" type="checkbox"/> Zero result when below MoD</p> <p>U.Offset (mm) <input type="text" value="18"/></p> <p>Pressure DEPTH Setting</p> <p><input checked="" type="checkbox"/> Zero result on FAIL</p> <p><input checked="" type="checkbox"/> Show -ve Depth</p> <p>P.Offset (mm) <input type="text" value="0"/></p> <p><input checked="" type="checkbox"/> Enable Barometric Ref.</p>	<p>CW VELOCITY Settings</p> <p><input checked="" type="checkbox"/> Zero result on RSSI fail</p> <p><input checked="" type="checkbox"/> Zero result on SPREAD fail</p> <p><input type="checkbox"/> Enable -ve (reverse) VELOCITY</p> <p><input checked="" type="checkbox"/> Enable over-range limit</p> <p>Min Op Depth (mm) <input type="text" value="40"/></p> <p>Min RSSI (Signal) <input type="text" value="4"/></p> <p>Max Signal Spread <input type="text" value="1000"/></p>	<p>CONDUCTIVITY Settings</p> <p>Ref. Temp (°C) <input type="text" value="25"/></p>
--	--	---	---	---

Settings:

Serial No. - This is not configurable

QSD Settings:

QSD Modbus Addr – This can be set between 0-254 for multiple Modbus instruments on a single bus.

Low Battery (V) – This Voltage setting determines when the Ultrasonic sensors will no longer be powered to take measurements. i.e., if the setting is 10.5V, then ultrasonics will no longer take readings until the power returns to above 10.5V. The minimum value is 8V.

SDI-12 Settings:

SDI-12 Addr. – This can be set according to how many instruments are on a single SDI-12 bus

U.Sonic DEPTH Settings:

Zero result when below MoD – This will provide a zero-value reading if the Ultrasonic level is below the Minimum operating depth (40mm); if not enabled, it may provide sporadic results if the depth is too low.

U.Offset (mm) – This is the offset between the base of the unit and the Ultrasonic sensor; this value is added to the depth above the sensor when data is recorded.
Pressure DEPTH Settings:

Zero result on FAIL – If the Pressure sensor has failed or is unable to take a reading, the returned result will be zero.

Show -ve Depth – As the sensor is non-vented the depth can record small negative readings; this can be enabled to show these.

P.Offset (mm) – As the sensor is non-vented the pressure sensor value may vary on site compared to when it's sent from the factory, this value allows for the offset to be adjusted, once the instrument is installed.

Enable Barometric Ref – Enable the use of the external barometric reference module (6515)

CW Velocity Settings:

Zero Result on RSSI Fail – If the Signal strength is poor in the water and if this setting is enabled, instrument will return a result of zero for velocity. Otherwise, it will return the last known velocity when the signal was above the minimum RSSI setting.

Zero Result on Spread Fail - If the Signal quality is poor, i.e., turbulent in the water, then if this setting is enabled will return a result of zero for velocity otherwise will return the last known velocity when the signal was above the minimum signal spread setting.

Enable -ve (reverse) velocity – This will enable velocity in both directions. Usually used in tidal flows.

Enable over range limit – The velocity can be configured for multiple ranges; if the velocity exceeds the range, then when enabling this option, the velocity value provided is the maximum range value (i.e., 1673 mm/s). If not enabled, the value will wrap around and start trending down.

Min Op Depth (mm) – Minimum depth required for the velocity Ultrasonics to be enabled (switched on)

Min RSSI (Signal) – Minimum Signal required to provide accurate readings.

Max Signal Spread – The Spread setting is used to determine how accurate the data being reported is and if the Starflow QSD is picking up good signals or bad signals; if a spread higher than 1000 is generated, this generally says that the data being recorded is unreliable.

11.3.1. Log Buffer

Open the Log Buffer window by clicking on the Log Buffer icon. The Log Buffer window is where you set up the logger memory for recording data by selecting what to log and how often to log it. Starflow QSD loggers have one Main buffer.

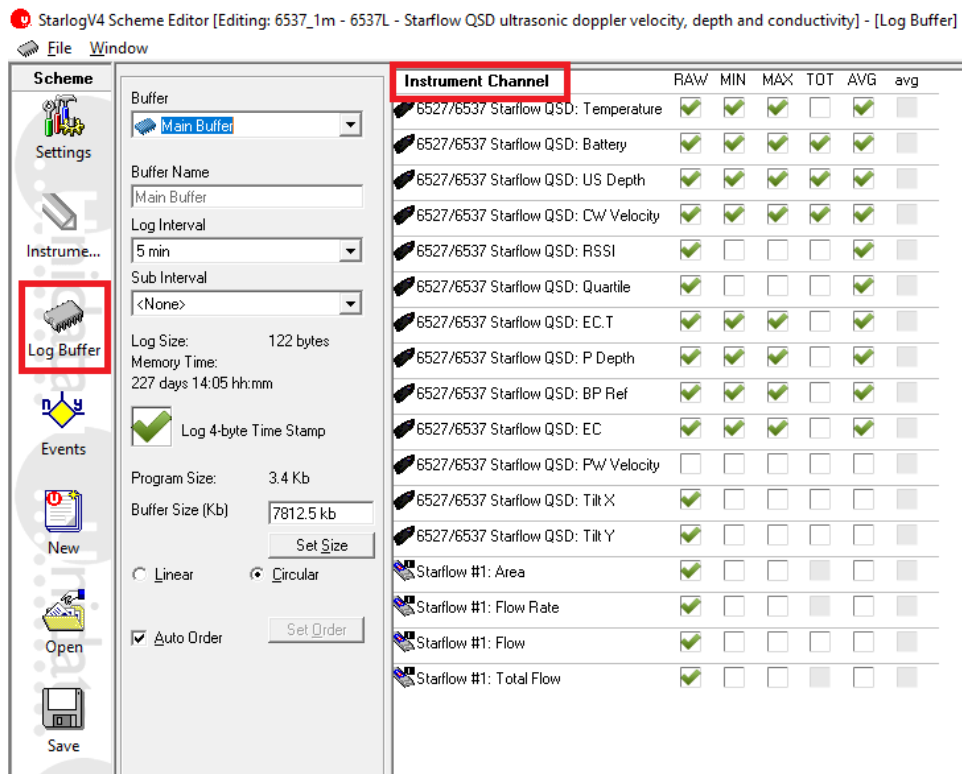

11.3.2. Instrument Channels

The following channel logging options are available; however, some instrument channels may not support all of them (for example, temperature cannot be totalised).

Option	Description
RAW	The instantaneous value of the channel at the time of the log.
MIN	The minimum of the values sampled at each scan over the log interval
MAX	The maximum of the values sampled at each scan over the log interval
TOT	The total of the values sampled at each scan over the log interval
AVG	The average (arithmetic mean) of the values sampled at each scan over the log interval

11.3.3. Log Intervals

The Log Interval is the time between logs. At each log, all the Instrument Channels ticked will be recorded into the Log Buffer.

In the screenshot below, data will be logged every 5 minutes.

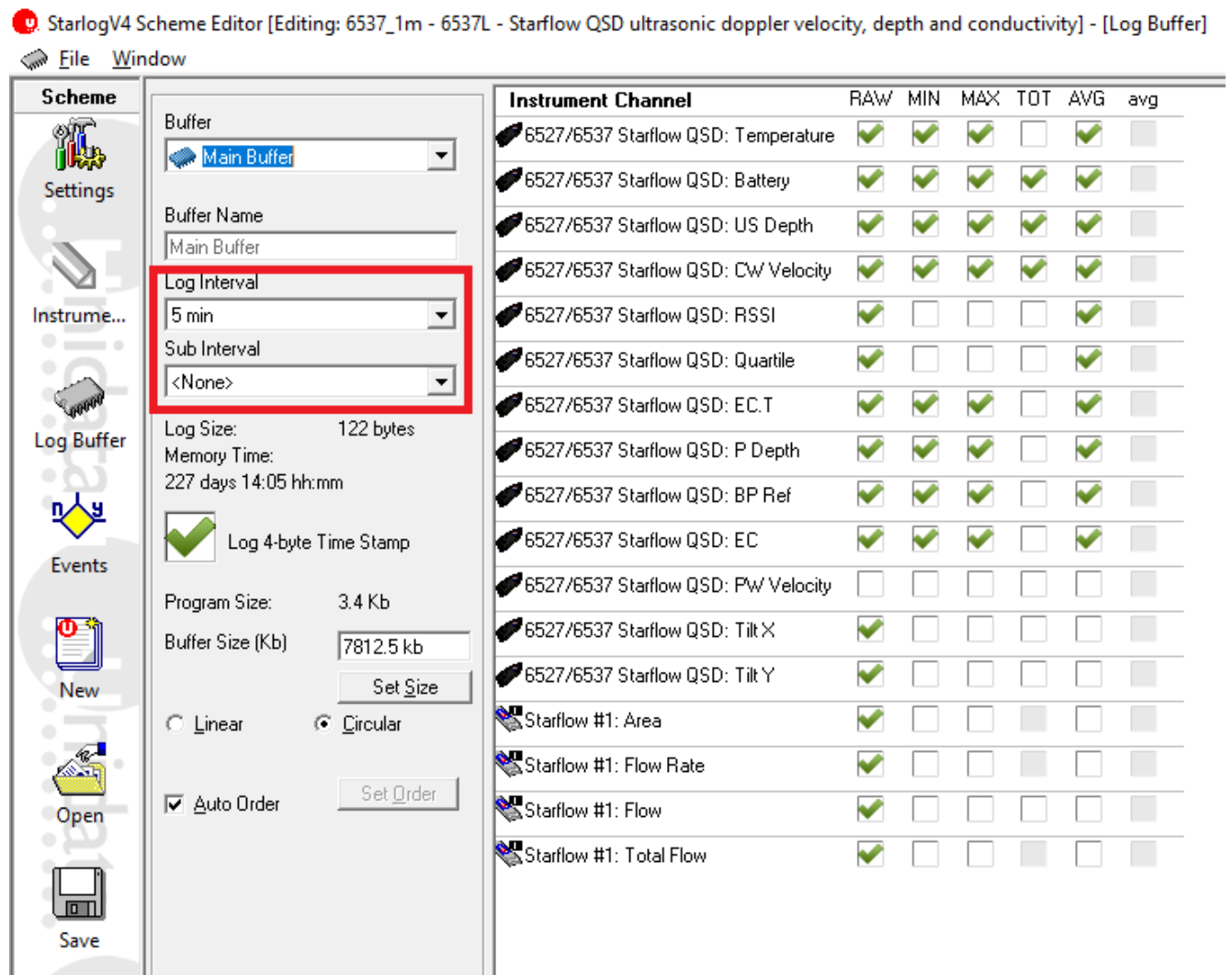

The maximum log interval is limited by the scan rate. The maximum log interval is 65535 times the scan rate. For example, if you set the scan rate to 1 second, the maximum logging interval is 65535 seconds, or 18 hours 12 minutes 15 seconds. If you want a log interval of 1 day, you will need a scan rate of at least 2 seconds.

Instrument Channel Ordering: This defaults to Auto Order; however, you can un-tick the checkbox and click on the Set Order button to manually set the logging order of the channels.

Note: You should NOT select AVE values to record for Flow Rate, Flow and Total Flow channels, as these are already processed and cannot be averaged.

11.3.4. Saving the Scheme

StarlogV4 Scheme Editor [Editing: 6537_1m - 6537L - Starflow QSD ultrasonic doppler velocity, depth and conductivity] - [Log Buffer]

File Window

Scheme

Settings

Instrume...

Log Buffer

Events

New

Open

Save

Buffer: Main Buffer

Buffer Name:

Log Interval: 5 min

Sub Interval: <None>

Log Size: 122 bytes

Memory Time: 227 days 14:05 hh:mm

Log 4-byte Time Stamp

Program Size: 3.4 Kb

Buffer Size (Kb): Set Size

Linear Circular

Auto Order Set Order

Instrument Channel	RAW	MIN	MAX	TOT	AVG	avg
6527/6537 Starflow QSD: Temperature	<input checked="" type="checkbox"/>	<input checked="" type="checkbox"/>	<input checked="" type="checkbox"/>	<input type="checkbox"/>	<input checked="" type="checkbox"/>	<input type="checkbox"/>
6527/6537 Starflow QSD: Battery	<input checked="" type="checkbox"/>	<input checked="" type="checkbox"/>	<input checked="" type="checkbox"/>	<input checked="" type="checkbox"/>	<input checked="" type="checkbox"/>	<input type="checkbox"/>
6527/6537 Starflow QSD: US Depth	<input checked="" type="checkbox"/>	<input checked="" type="checkbox"/>	<input checked="" type="checkbox"/>	<input checked="" type="checkbox"/>	<input checked="" type="checkbox"/>	<input type="checkbox"/>
6527/6537 Starflow QSD: CW Velocity	<input checked="" type="checkbox"/>	<input checked="" type="checkbox"/>	<input checked="" type="checkbox"/>	<input checked="" type="checkbox"/>	<input checked="" type="checkbox"/>	<input type="checkbox"/>
6527/6537 Starflow QSD: RSSI	<input checked="" type="checkbox"/>	<input type="checkbox"/>	<input type="checkbox"/>	<input type="checkbox"/>	<input checked="" type="checkbox"/>	<input type="checkbox"/>
6527/6537 Starflow QSD: Quartile	<input checked="" type="checkbox"/>	<input type="checkbox"/>	<input type="checkbox"/>	<input type="checkbox"/>	<input checked="" type="checkbox"/>	<input type="checkbox"/>
6527/6537 Starflow QSD: EC.T	<input checked="" type="checkbox"/>	<input checked="" type="checkbox"/>	<input checked="" type="checkbox"/>	<input type="checkbox"/>	<input checked="" type="checkbox"/>	<input type="checkbox"/>
6527/6537 Starflow QSD: P Depth	<input checked="" type="checkbox"/>	<input checked="" type="checkbox"/>	<input checked="" type="checkbox"/>	<input type="checkbox"/>	<input checked="" type="checkbox"/>	<input type="checkbox"/>
6527/6537 Starflow QSD: BP Ref	<input checked="" type="checkbox"/>	<input checked="" type="checkbox"/>	<input checked="" type="checkbox"/>	<input type="checkbox"/>	<input checked="" type="checkbox"/>	<input type="checkbox"/>
6527/6537 Starflow QSD: EC	<input checked="" type="checkbox"/>	<input checked="" type="checkbox"/>	<input checked="" type="checkbox"/>	<input type="checkbox"/>	<input checked="" type="checkbox"/>	<input type="checkbox"/>
6527/6537 Starflow QSD: PW Velocity	<input type="checkbox"/>	<input type="checkbox"/>	<input type="checkbox"/>	<input type="checkbox"/>	<input type="checkbox"/>	<input type="checkbox"/>
6527/6537 Starflow QSD: Tilt X	<input checked="" type="checkbox"/>	<input type="checkbox"/>	<input type="checkbox"/>	<input type="checkbox"/>	<input type="checkbox"/>	<input type="checkbox"/>
6527/6537 Starflow QSD: Tilt Y	<input checked="" type="checkbox"/>	<input type="checkbox"/>	<input type="checkbox"/>	<input type="checkbox"/>	<input type="checkbox"/>	<input type="checkbox"/>
Starflow #1: Area	<input checked="" type="checkbox"/>	<input type="checkbox"/>	<input type="checkbox"/>	<input type="checkbox"/>	<input type="checkbox"/>	<input type="checkbox"/>
Starflow #1: Flow Rate	<input checked="" type="checkbox"/>	<input type="checkbox"/>	<input type="checkbox"/>	<input type="checkbox"/>	<input type="checkbox"/>	<input type="checkbox"/>
Starflow #1: Flow	<input checked="" type="checkbox"/>	<input type="checkbox"/>	<input type="checkbox"/>	<input type="checkbox"/>	<input type="checkbox"/>	<input type="checkbox"/>
Starflow #1: Total Flow	<input checked="" type="checkbox"/>	<input type="checkbox"/>	<input type="checkbox"/>	<input type="checkbox"/>	<input type="checkbox"/>	<input type="checkbox"/>

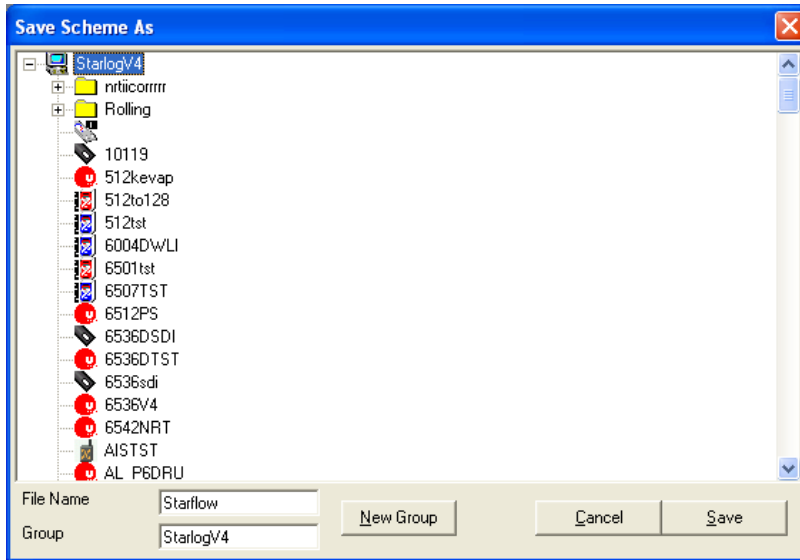

To save your scheme, click the **Save** icon.

If you've saved your scheme before it will immediately save it. If you've never saved the scheme before, the dialog shown below will appear. You can get the same dialog at any time by selecting **Save Scheme as** from the **File** menu.

Enter the scheme name in the **File Name** field. There is a maximum length of eight characters.

The **New Group** button allows you to create sub-folders of schemes. Groups may be created inside groups, too.

12. PROGRAMMING STARFLOW QSD

Loggers are programmed from the main screen, by clicking on the Program icon, shown to the right. You will be asked to confirm before the programming will proceed:

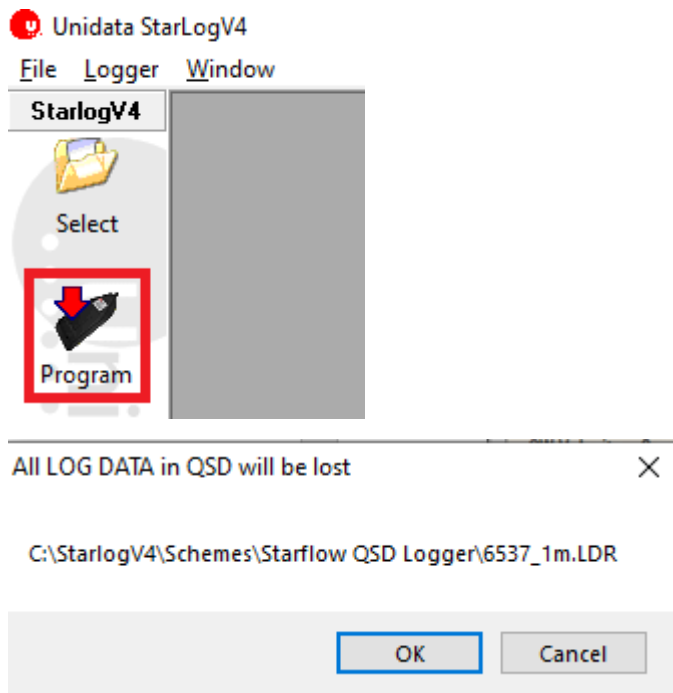

Clicking **OK** will program the new scheme.

If all goes well, a **Logger successfully re-programmed** message will appear. Click **OK** to close the progress window.

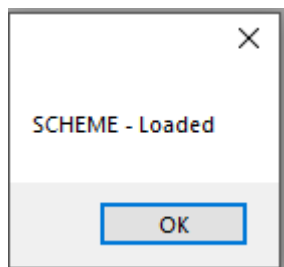

13. TEST MODE

Test Mode is used to check the status of the logger, and to monitor its logging progress.

To enter Test Mode, click on the Test Mode icon. A window like the following will appear:

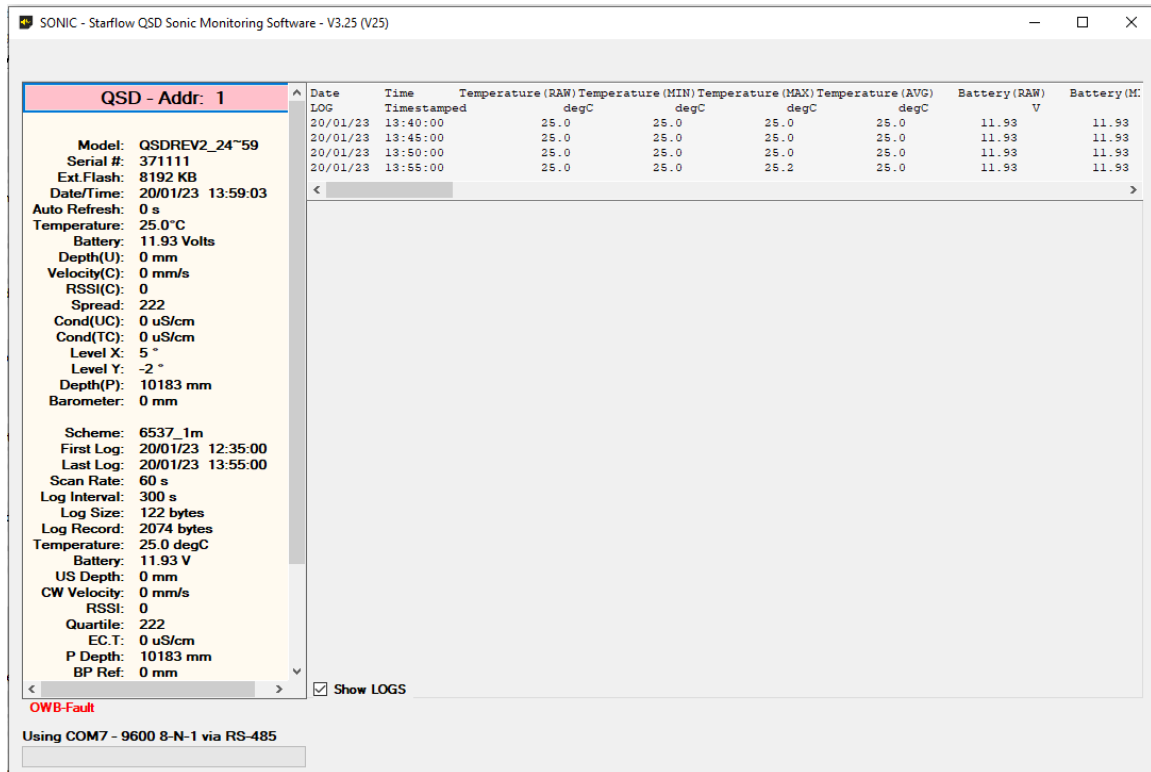
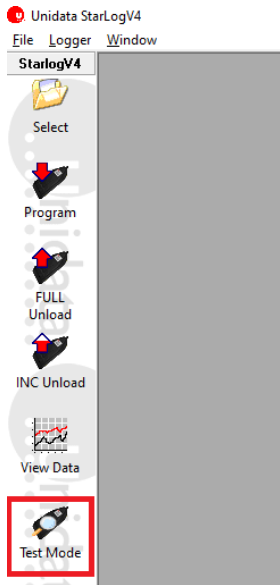

The **Scheme** shows the name of the scheme that has been programmed into the logger. The scheme logging parameters can be checked as highlighted below, on the right side of the screen, live logged data can be viewed.

13.1. Scheme Channels

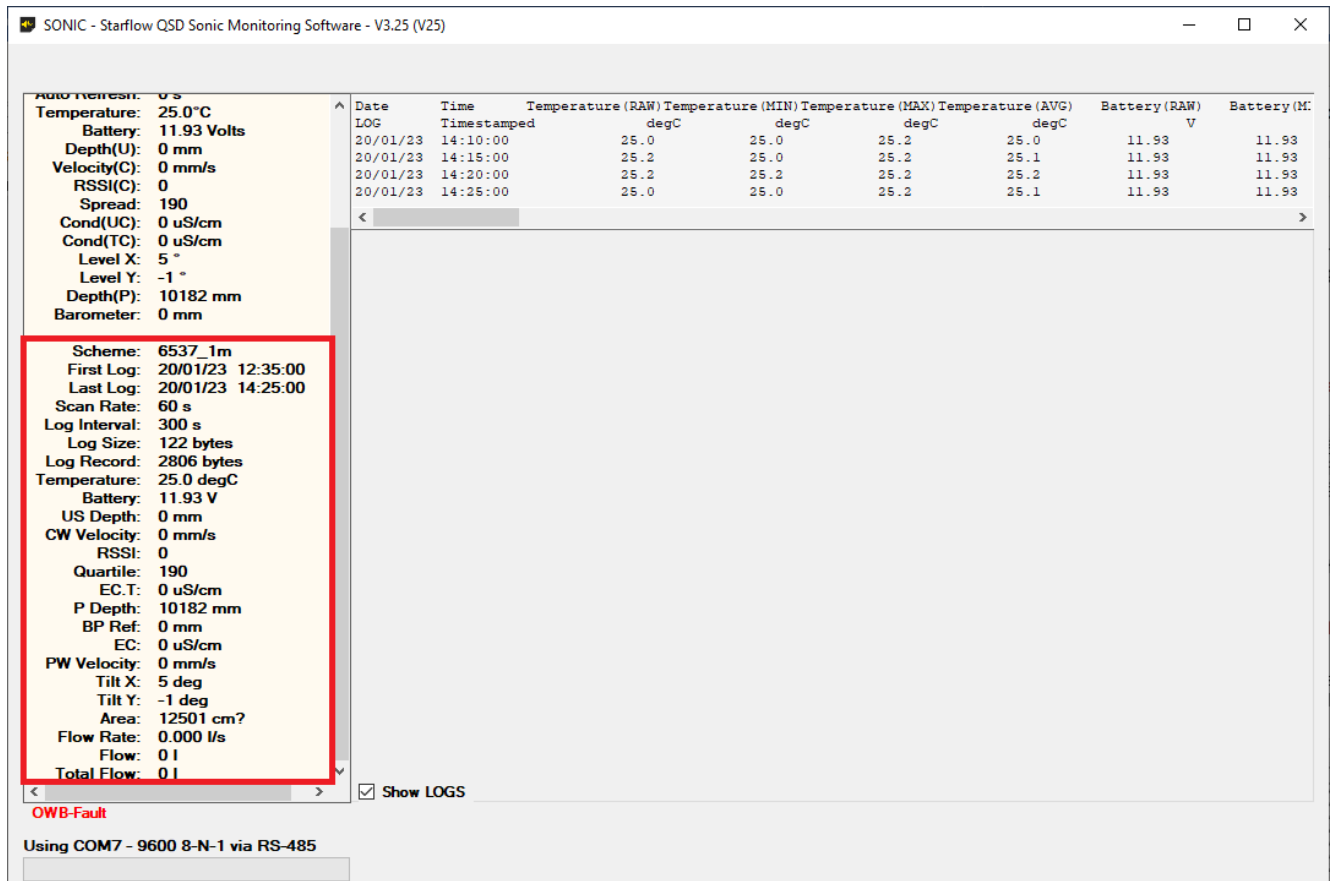

The screenshot shows the SONIC - Starflow QSD Sonic Monitoring Software interface. On the left, there is a list of 'Scheme Channels' with various sensor readings. A red box highlights the 'Scheme' section, which includes the following details:

- Scheme: 6537_1m
- First Log: 20/01/23 12:35:00
- Last Log: 20/01/23 14:25:00
- Scan Rate: 60 s
- Log Interval: 300 s
- Log Size: 122 bytes
- Log Record: 2806 bytes
- Temperature: 25.0 degC
- Battery: 11.93 V
- US Depth: 0 mm
- CW Velocity: 0 mm/s
- RSSI: 0
- Quartile: 190
- EC.T: 0 uS/cm
- P Depth: 10182 mm
- BP Ref: 0 mm
- EC: 0 uS/cm
- PW Velocity: 0 mm/s
- Tilt X: 5 deg
- Tilt Y: -1 deg
- Area: 12501 cm²
- Flow Rate: 0.000 l/s
- Flow: 0 l
- Total Flow: 0 l

On the right side of the interface, there is a table of logged data:

Date	Time	Temperature (RAW)	Temperature (MIN)	Temperature (MAX)	Temperature (AVG)	Battery (RAW)	Battery (M)
LOG	Timestamped	degC	degC	degC	degC	V	
20/01/23	14:10:00	25.0	25.0	25.2	25.0	11.93	11.93
20/01/23	14:15:00	25.2	25.0	25.2	25.1	11.93	11.93
20/01/23	14:20:00	25.2	25.2	25.2	25.2	11.93	11.93
20/01/23	14:25:00	25.0	25.0	25.2	25.1	11.93	11.93

At the bottom of the window, there is a status bar showing 'OWB-Fault' and 'Using COM7 - 9600 8-N-1 via RS-485'. A 'Show LOGS' checkbox is also visible.

The Scheme Channels display the current readings of the instruments connected to the logger; these will update according to the scan rate that has been set.

14. UNLOADING DATA FROM LOGGERS

Once you've had your logger operating for a while, it will have recorded some data. Unloading is the action of copying the data stored in the data logger into a CSV (comma-separated value) file on your computer.

CSV files can be directly opened in Excel and are also a common format supported by other software, Hydsys.

Unloaded CSV data files are stored in a scheme sub-folder of the folder specified by the **Data Path** option for Version 4 schemes.

To unload logged data from your data logger to your PC, click on the **Full Unload** icon (shown to the right). The following window will appear:

Full Unload: This unloads all the data available on the logger into a new CSV file.

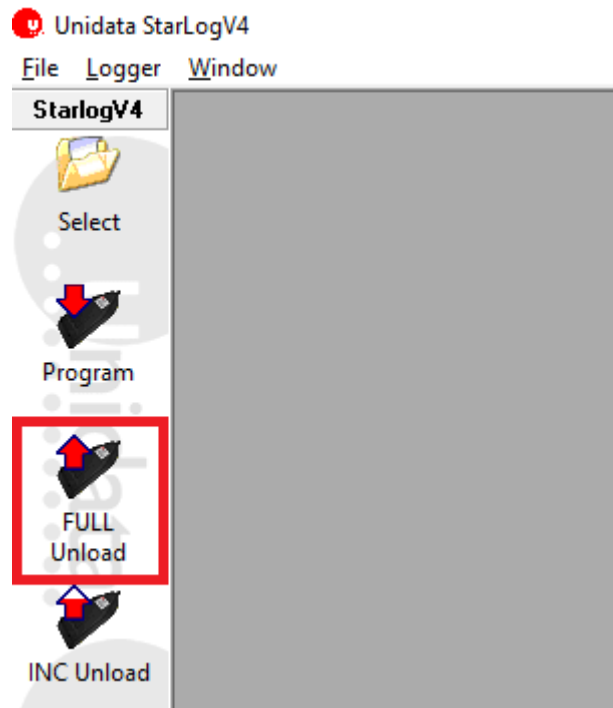

SONIC - Starflow QSD Sonic Monitoring Software - V3.25 (V25)

QSD - Addr: 1

Model: QSDREV2_24~59
 Serial #: 371111
 Ext.Flash: 8192 KB
 Date/Time: 20/01/23 16:08:40
 Auto Refresh: 0 s
 Temperature: 25.0°C
 Battery: 11.93 Volts
 Depth(U): 0 mm
 Velocity(C): 0 mm/s
 RSSI(C): 0
 Spread: 277
 Cond(UC): 0 uS/cm
 Cond(TC): 0 uS/cm
 Level X: 6 °
 Level Y: -1 °
 Depth(P): 10174 mm
 Barometer: 0 mm

Scheme: 6537_1m
 First Log: 20/01/23 12:35:00
 Last Log: 20/01/23 16:05:00
 Scan Rate: 60 s
 Log Interval: 300 s
 Log Size: 122 bytes
 Log Record: 5246 bytes
 Temperature: 25.0 degC
 Battery: 11.93 V
 US Depth: 0 mm
 CW Velocity: 0 mm/s
 RSSI: 0
 Quartile: 277
 EC.T: 0 uS/cm
 P Depth: 10174 mm
 BP Ref: 0 mm

Date	Time	Temperature (RAW)	Temperature (MIN)	Temperature (MAX)	Temperature (AVG)	Battery (RAW)	Battery (M)
LOG	Timestamped	degC	degC	degC	degC	V	
20/01/23	15:50:00	25.0	25.0	25.2	25.0	11.93	11.93
20/01/23	15:55:00	25.0	25.0	25.0	25.0	11.93	11.93
20/01/23	16:00:00	25.0	25.0	25.0	25.0	11.93	11.93
20/01/23	16:05:00	25.0	25.0	25.0	25.0	11.93	11.93

OWB-Fault

Using COM7 - 9600 8-N-1 via RS-485

371111.sfd Contains 43 records from 20/01/23 12:35:00 to- 20/01/23 16:05:00

Saved 43 records - From 20/01/23 12:35:00 -to- 20/01/23 16:05:00 in C:\StarlogV4\DATA\Starflow QSD Logger\6537_1m\Main Buffer\6537_1m_04.csv

Show LOGS

Incremental Unload: This unloads all data logged since the last time you unloaded the logger. If you've never unloaded the logger since you programmed it, this will be a Full Unload.

Unidata StarLogV4

File Logger Window

StarlogV4

- Select
- Program
- FULL Unload
- INC Unload

When complete, the newly unloaded data will be added to the data file location where the software has been installed.

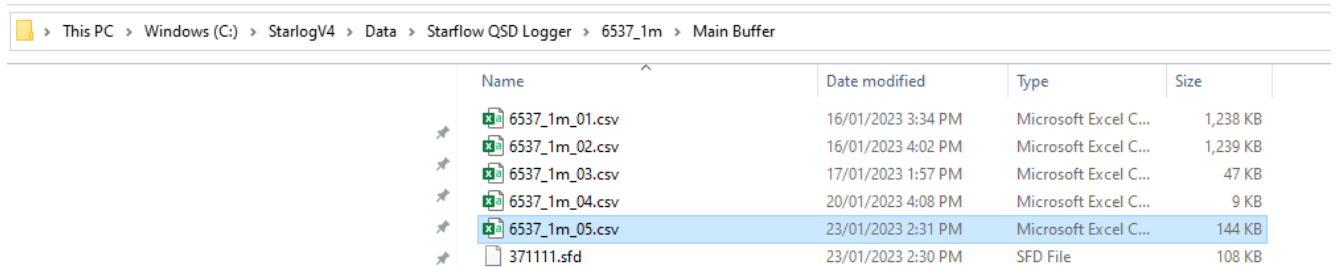

The screenshot shows a Windows File Explorer window with the following path: This PC > Windows (C:) > StarlogV4 > Data > Starflow QSD Logger > 6537_1m > Main Buffer. The file list is as follows:

Name	Date modified	Type	Size
6537_1m_01.csv	16/01/2023 3:34 PM	Microsoft Excel C...	1,238 KB
6537_1m_02.csv	16/01/2023 4:02 PM	Microsoft Excel C...	1,239 KB
6537_1m_03.csv	17/01/2023 1:57 PM	Microsoft Excel C...	47 KB
6537_1m_04.csv	20/01/2023 4:08 PM	Microsoft Excel C...	9 KB
6537_1m_05.csv	23/01/2023 2:31 PM	Microsoft Excel C...	144 KB
3711111.sfd	23/01/2023 2:30 PM	SFD File	108 KB

You can view a CSV file by double-clicking on it, in the list.

15. VIEWING DATA

Starlog V4 is not data processing software. We recommend that you use Hydsys, or similar to process data. The data viewer is for functional testing only.

To view data that you have previously unloaded, click the **View Data** icon (shown to the right). The following window will appear:

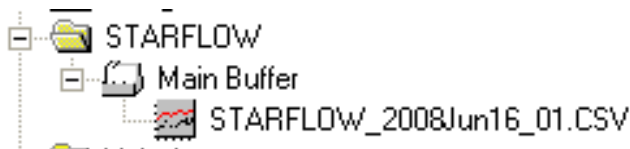
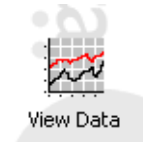

Initially, only the **Source Data File** tab is available. This is where you select the data you want to view.

15.1. Starlog V4 (*.CSV) Files

These files are grouped by the scheme.

The following screenshot shows that there is a scheme called **Starflow QSD**, which has available data from its **Main Buffer**, and the only data file available is a file called **STARFLOW QSD_2008Jun16.CSV**.

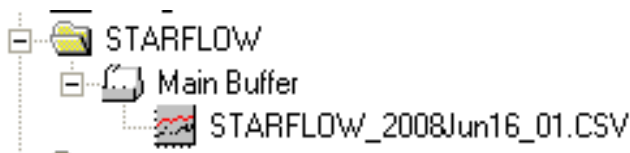

15.2. Viewing the Data File

Once you've located the data file you want to view, there are several ways to open it:

Double-click on it to open it using the Starlog V4 built-in Data Viewer Right-click on it to open a context menu:

The "Open with" options are described below. The Send To, Copy, Delete, and Open containing folder are all handled the same as when you right-click on a file in the standard Windows file Explorer.

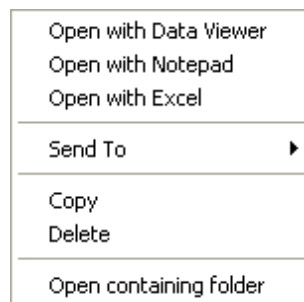

15.2.1. Graph View

The default mode for viewing your data is **Graph View**. This shows a zoomable graph on the left and individually selectable channels on the right. Untick or tick channels to hide or show them. The legend may be moved by dragging it to a new position.

The graph is zoomable by clicking and dragging out the rectangular area you want to zoom in to. Reset the zoom by right-clicking on the graph. The zoom level is also reset when you make a change to the visibility of any channel.

The example below has the Battery channel turned off, leaving the Internal Temp:

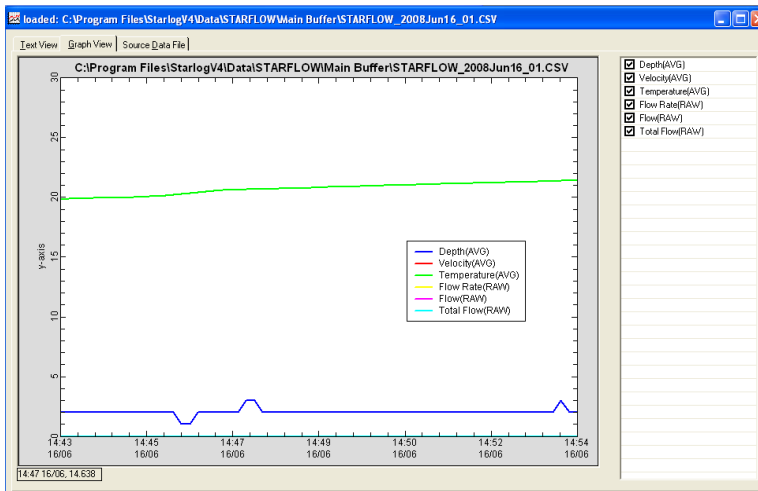

When you hover your mouse over the graph, the time of log of the data you're hovering is shown at the bottom left, next to the scrollbar.

15.2.2. Table View

The **Table View** shows your logged data in a tabular form. The column widths are adjustable by dragging the divider between them. Use the scroll bar to select the data to view.

Date Time	Temperature(R...	Temperature(MI...	Temperature(M...	Temperature(A...	Battery(RAW)
20/01/2023 4:1...	25	25	25	25	11.93
20/01/2023 4:1...	25	25	25	25	11.93
20/01/2023 4:2...	25	25	25	25	11.93
20/01/2023 4:2...	25	25	25	25	11.93
20/01/2023 4:3...	25	24.7	25	24.9	11.93
20/01/2023 4:3...	25	24.7	25	24.9	11.93
20/01/2023 4:4...	24.7	24.7	25	24.7	11.93
20/01/2023 4:4...	24.7	24.7	24.7	24.7	11.93
20/01/2023 4:5...	24.7	24.7	24.7	24.7	11.93
20/01/2023 4:5...	24.7	24.7	24.7	24.7	11.93
20/01/2023 5:0...	24.7	24.7	24.7	24.7	11.93
20/01/2023 5:0...	24.7	24.7	24.7	24.7	11.93
20/01/2023 5:1...	24.7	24.7	24.7	24.7	11.93
20/01/2023 5:1...	24.7	24.7	24.7	24.7	11.93
20/01/2023 5:2...	24.7	24.7	24.7	24.7	11.93
20/01/2023 5:2...	24.7	24.7	24.7	24.7	11.93
20/01/2023 5:3...	24.7	24.5	24.7	24.6	11.93
20/01/2023 5:3...	24.7	24.7	24.7	24.7	11.93
20/01/2023 5:4...	24.5	24.5	24.7	24.6	11.93

15.2.3. Opening with Notepad

Opening your data file in Notepad can be useful if you suspect some file corruption. Notepad doesn't try to interpret the data, so you can scan through it and manually correct any anomalies.

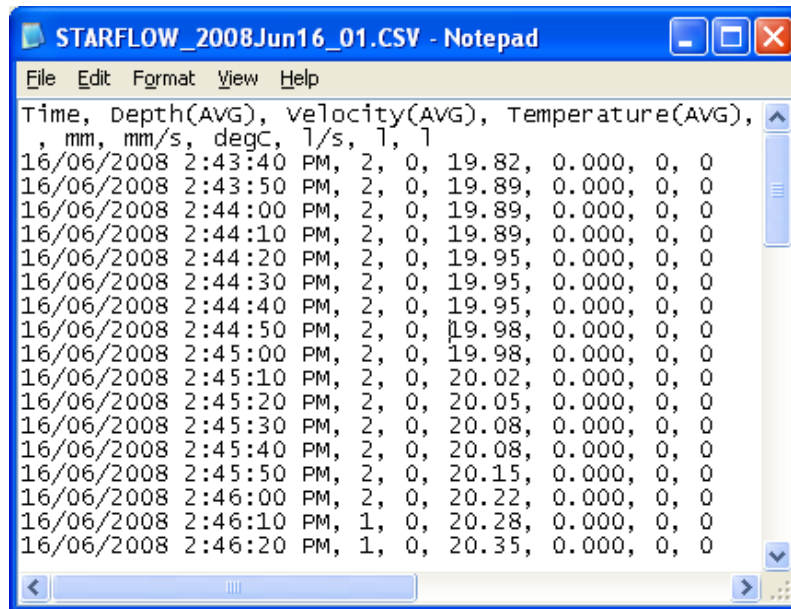

15.2.4. Opening with Excel

Opening your data in Excel gives you a lot more power to display, format, print, and analyse your data. When opened in Excel, two sheets are created; the first one is for viewing the data in a tabular format:

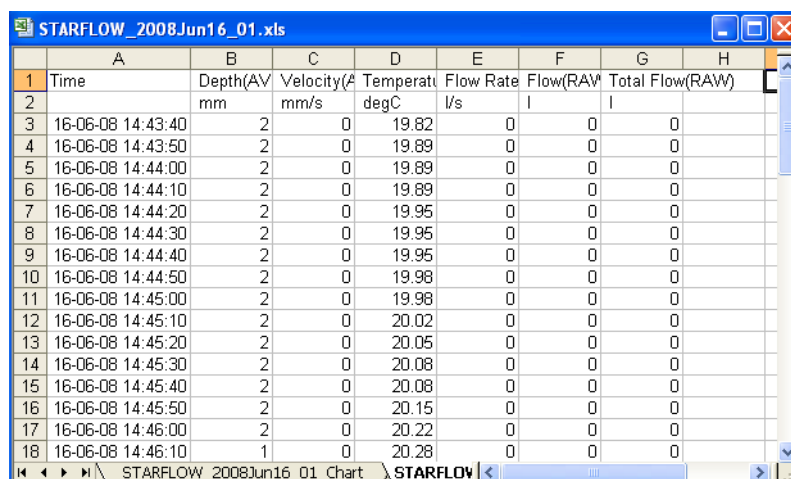

There is also a second sheet called "filename_Chart" that displays the data as a graph:

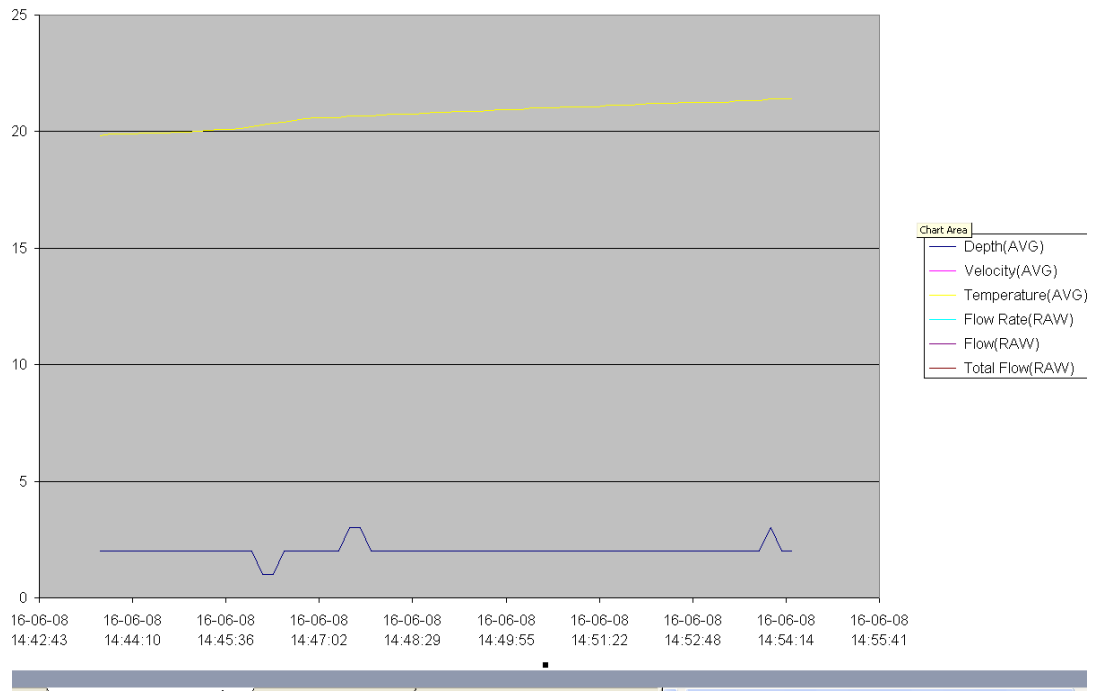

17. DIAGNOSTICS

Diagnostics are accessed from the main Starlog V4 window by selecting the Diagnostics tab on the left toolbar. Please see the screenshot to the right.

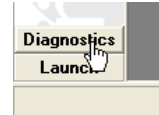

Diagnostics provides several functions to assist you with various problems you may encounter using data loggers. Each function is explained below:

17.1. Velocity Trace

This facility helps you to learn more about using Starflow QSD for flow measurement. It lets you look at the velocity data the Starflow QSD is recording and experiment with ways of improving the signal.

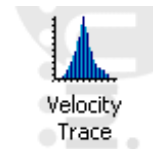

This program displays as a histogram the velocities collected during each measuring cycle. It lets you observe the “shape” of the signal and review a “mean” velocity calculated in several ways. Using this, you may carry out tests and experiments in various flow environments.

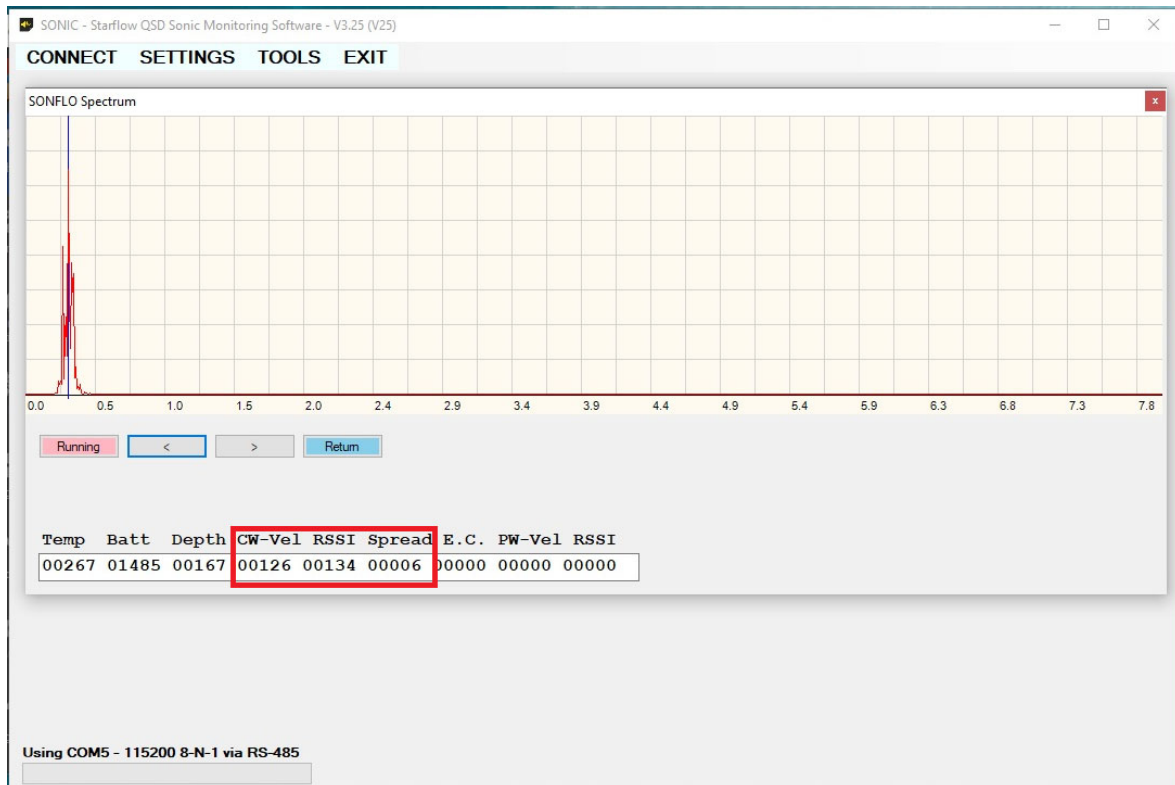

17.2. Velocity Histograms

The Velocity Histograms that you will see by using Velocity Trace from the Control Panel are the Starflow QSD’s view of the channel. It is the composite of a range of factors, including both characteristics of the equipment, the sampling method, and the velocity dynamics within the channel. The following statistics are computed from the range of Doppler shifts measured for each cycle.

CW-Vel Median:

The computed median of all the Doppler shifts detected, measured in mm/sec. This is the value presently logged.

Spread:

A ratio of the width of the peak to the height. This can provide an indication of the “quality” of the histogram. 10% to 80% are typical values. A transducer buried in the sand will give a large value.

Maximum:

The Doppler shift of the peak of the histogram, in mm/s, is indicated by the green line.

The screen will cycle, refreshing the plot and summaries each time a new set of samples are acquired.

The following examples are shown as you would see them on your screen.

An ideal signal, when presented as a histogram, appears as a symmetrical peak. The x-axis represents the velocity in mm/sec. The y-axis indicates the relative number of times a particular velocity has been received. The approximate “centre” of this peak is the value of the velocity we are looking for, as it will be the mean of all the echoes received.

As the velocity changes, the peak will be seen to move back and forth along the x-axis.

Note: The Velocity Trace does not indicate Flow Direction, only Velocity magnitude. The width of the peak indicates that a range of velocities is

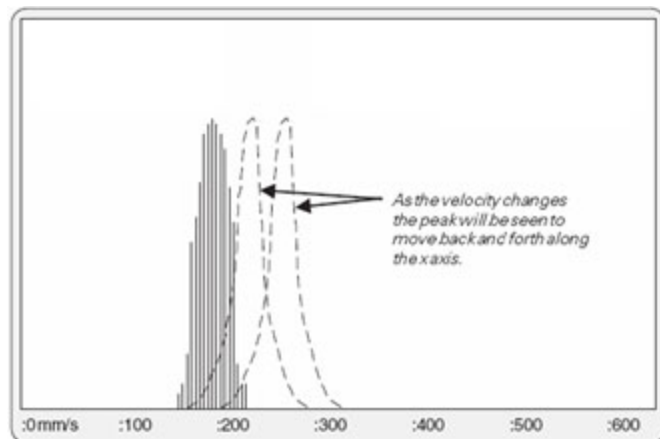

being measured with each reading. The narrowest of peaks would be obtained in the ideal conditions of perfectly laminar, tranquil flows in water with an even distribution of reflective particles. These would still be 50—100 mm/sec wide and would appear as above.

In fast turbulent water, the peak can be 500 mm/sec or wider because of the range of velocities present in eddies and swirls. The following histogram is typical.

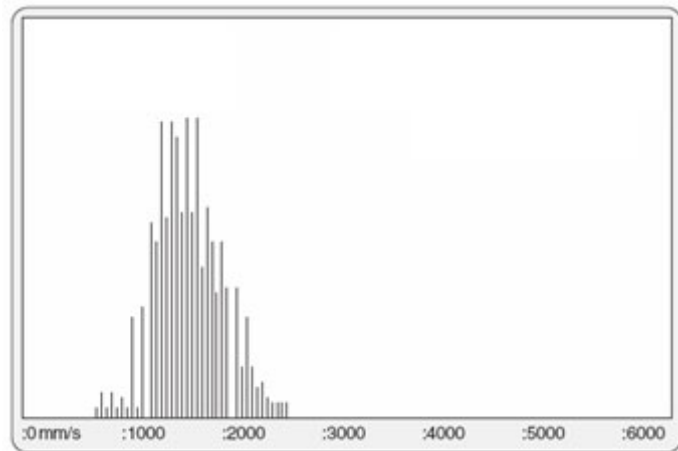

17.3. Inherent Factors in Doppler Histograms

The width and shape of the peak displayed are caused by a range of factors, all of which are measured by the Doppler as a frequency shift.

Some of these factors are inherent in the method.

In flowing channels, there is always a range of different velocities present, but even in “perfect” conditions, with all water flowing at the same velocity, the histogram displayed will still have a characteristic “skinny bell” shape.

This is a composite of a variety of effects related to using Dopplers to measure water velocity in streams.

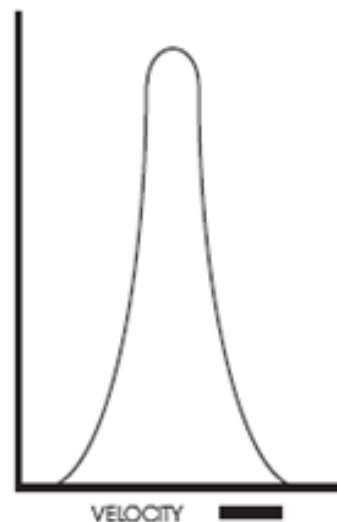

17.4. Varying Angles as Particles Pass through the Main Beam

The acoustic beam has a width or spread, of about 3°. The centreline of the beam is aligned at 30° above horizontal as a particle passes horizontally through.

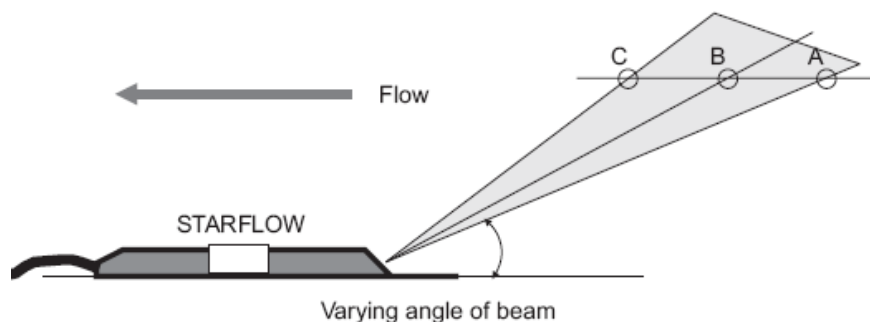

The Doppler shift measured is the velocity component along the line between the particle and the transmitter, so this changes by 5% as the particle traverses the beam.

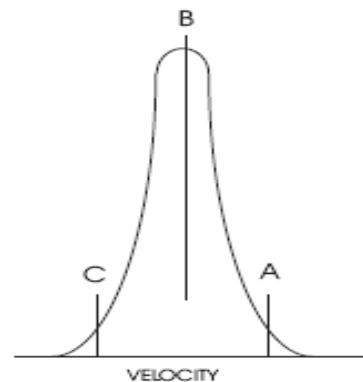

17.5. Measuring Errors Due To “Signal Noise”

“Signal Noise” is a convenient term used to classify any Doppler shifts that cannot be explained as legitimate measurements of water velocity. The Starflow QSD measures tiny signals echoed back from small particles along a path scattered with many other particles, all in motion. The returned signals are sometimes echoes of echoes, vague and ambiguous and can be misinterpreted by the measuring circuits resulting in an incorrect Doppler shift.

These result in frequency shifts being measured that are outside the range of velocities expected. They can represent several percent of measurements in a scan but are typically widely distributed. They are usually statistically irrelevant because of the signal analysis techniques used to define the median.

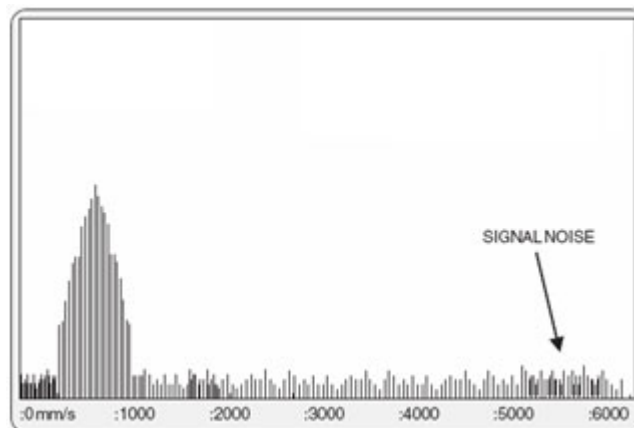

17.6. Channel Characteristics Affecting the Signal

All signals are affected by the factors discussed above. Additional factors related to channel and flow characteristics can influence the measured velocity. These result in a widening of the histogram base because of the broader spread of Doppler shifts measured.

In a channel with laminar flows, the shape of the peak remains symmetrical. If other factors disturb the velocity profiles within the field of view of the Starflow QSD, the histogram may become distorted. This may introduce a bias to the computed velocity.

If the shape of the histogram is the same from cycle to cycle, then it represents the Starflow QSD view of the channel and not some transient aberration. Hydrographers must decide if this represents a valid velocity measurement or if the site is unsuitable.

17.7. The Nature and Location of the “Reflectors” in the Water

The Starflow QSD measures echoed Doppler shifts from anything acoustically reflective in the signal beam. It cannot discriminate where the echo is coming from, and the bigger, closer reflectors will generate a stronger signal than smaller or more distant reflectors.

Reflectors can include:

- All types of particles in suspension.
- Alluvial saltation loads such as sand, pebbles and rocks moving at or near the bed.
- Leaves, sticks, and organic material.
- Surface waves from wind or velocity.
- Bubbles and entrapped air pockets.

During the time it takes to traverse the signal beam, a particularly good reflector can be measured 100 or more times. The velocity of this reflector may bias or dominate one velocity measurement. This will tend to be averaged out during the logging period if it only happens occasionally.

If it happens consistently, it is a site characteristic. The relevance of this to the mean channel velocity will need to be understood and compensated for in processing.

17.8. Velocity Variations Due to Cross-Section Changes

If changes to the channel cross section introduce different velocity regimes within the view of the Starflow QSD, the histogram is distorted. At low flows in clean streams, the beam can be reflected for some distance and “see” unexpected velocities from some distance away.

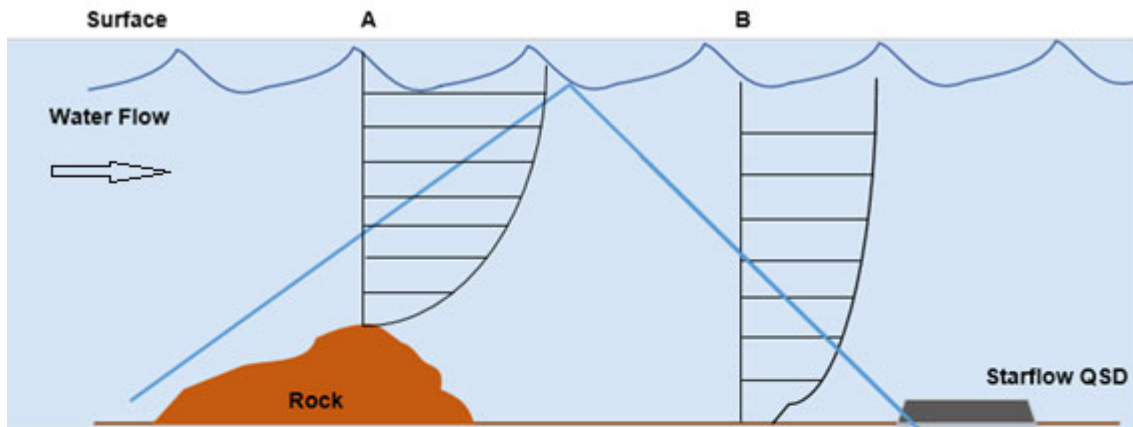

Example 1 : Velocity accelerating around rock

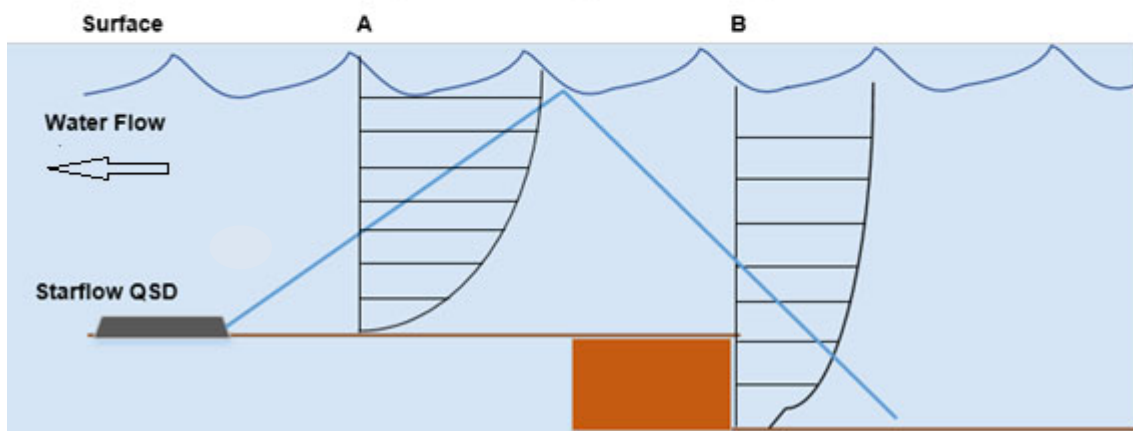

Example 2 : Velocity variations at culvert exit

Higher velocities could also be seen at localised parts of the channel where water accelerates around obstacles or still carries the effects of upstream higher velocities.

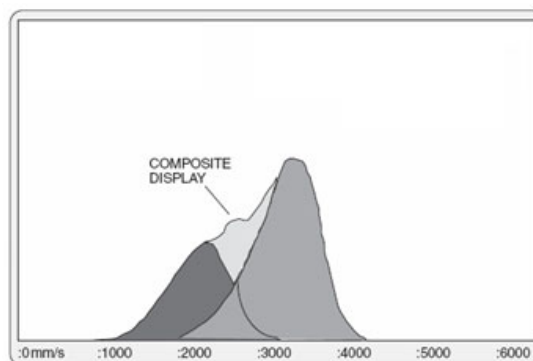

17.9. Measuring Unexpected Velocities

In some cases, signals are from the wrong targets. A waving weed, aquatic animals, a strong stationary reflector in the bed, slow-moving saltation targets or ripples on the surface can all produce Doppler shifts that are not directly related to the water velocity.

The “field of view” of the Starflow QSD can extend for at least 5m along the beam in clean water and reduces as the sediment load of the stream increases.

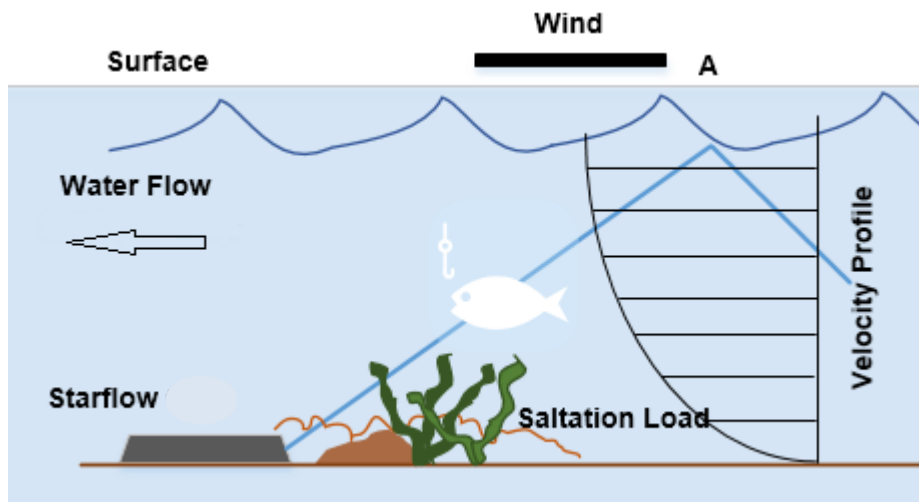

The beam can reflect from the surface underside and can detect different velocities than those expected. This results in a distorted peak, or a double or multiple peaks in some situations, the composite of all velocities seen along the path. Such sites may be unsuitable for the Starflow QSD as the flow is not laminar.

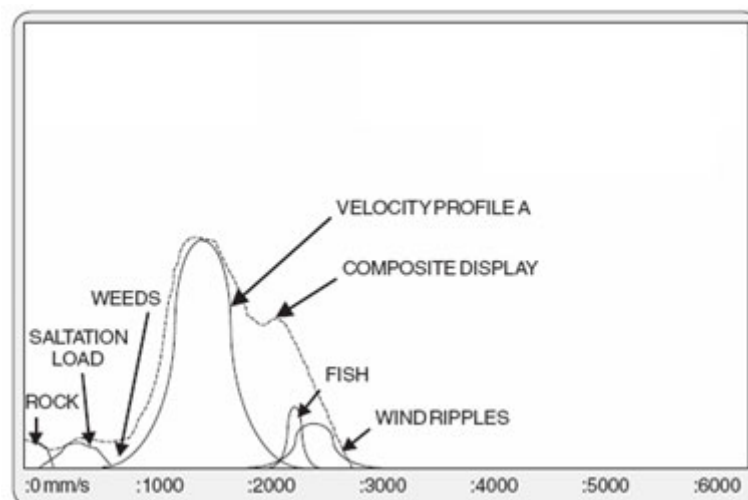

17.10. Measuring Turbulent Velocities

In higher bed slope streams, wide and multiple peaks may be displayed because of the complex moving landscape presented to the Starflow QSD. The fact that many repeats of similar velocity histograms are seen indicates that the different velocity components seen are valid. How to interpret such signals is the issue.

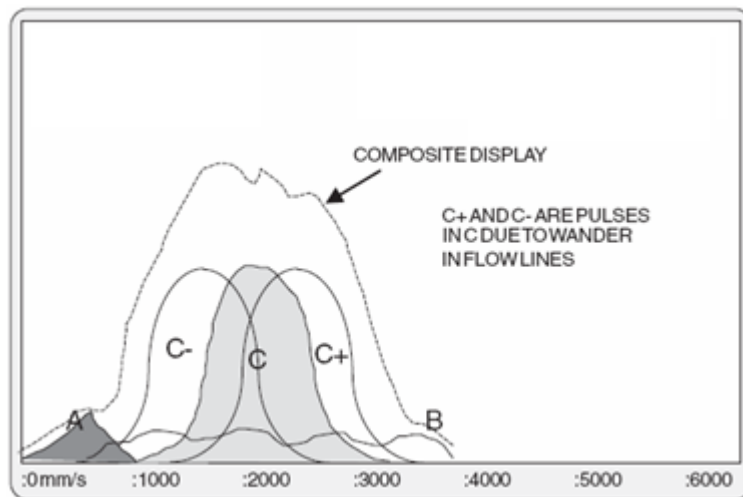
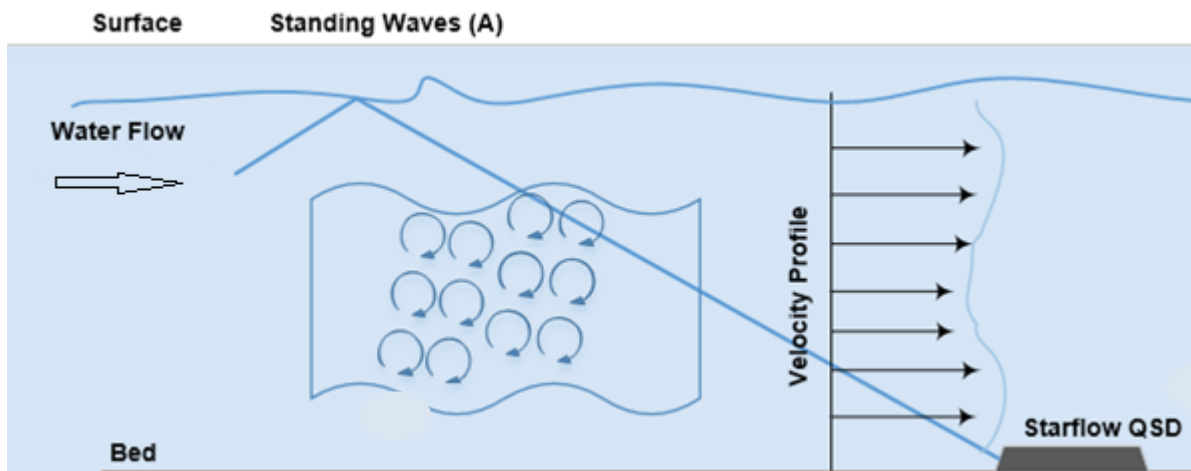

17.11. Effects of Surface Ripples

In shallow water, the presence of ripples or small waves on the surface can cause complications. The ripples may be caused by wind or be a feature of the channel caused by obstructions in the channel or by irregularities on the bank. Ripples will be moving at a different velocity to the water.

In shallow and clean water, the Starflow QSD can clearly see the surface. As the ripples move, they present a varying effect on the Doppler signal. At times the ripples will be positioned so that the carrier reflects away from the Starflow QSD. A minor signal is detected, but many more signals are detected from the water, and a correct velocity is measured.

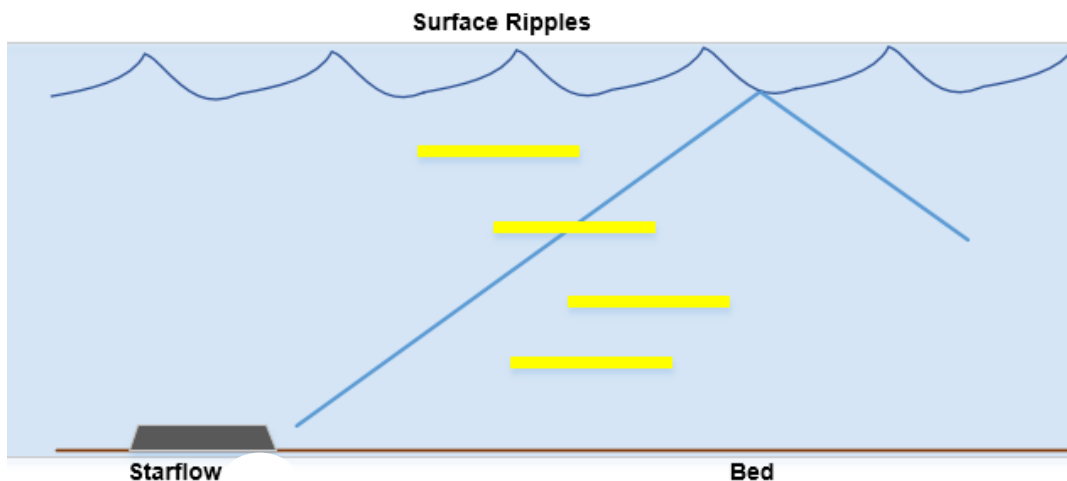

When the ripples move slightly, one can become positioned such that it becomes an “acoustic mirror”, reflecting back a powerful signal and dominating the signals from the channel. The median velocity will be biased toward the ripple velocity and will be incorrect.

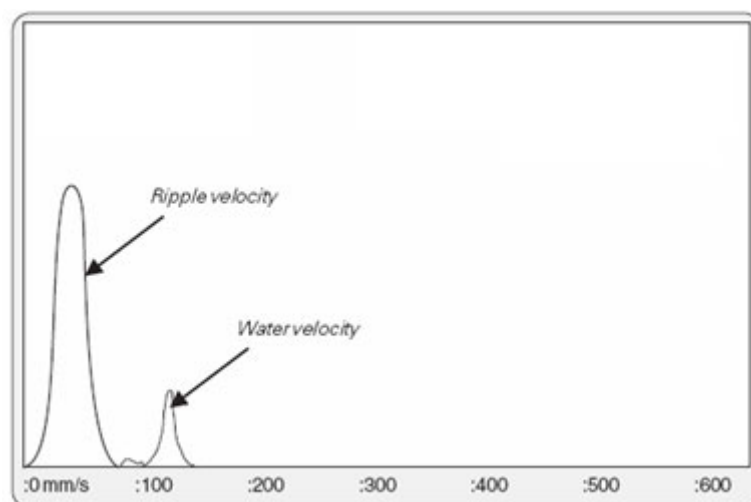

In practice, a series of histograms in such a situation will move back and forth between the two extreme conditions, logging an average that is not the correct velocity. At some sites, ripples will be a characteristic at certain levels. Positioning and orienting the Starflow QSD so that it does not point directly into a “mirror” ripple face is the best prevention.

17.12. Measuring Flows in Very Small Channels

The Starflow QSD can be installed in channels as narrow as 75mm. It can measure minimum velocities to 21mm/second in depths as low as 40mm. This flow rate is well below the measuring ability of most instruments, flumes, or weirs. However, the Starflow QSD may struggle to operate correctly in these extreme conditions. The following conditions may be seen.

- The RSSI will be reduced. As velocities slow, it takes the Starflow QSD longer to measure each Doppler shift. At shallow depths, the volume of water from which to acquire signals is reduced. These factors combine to mean the Starflow QSD will generally not be able to acquire good RSSI within the time allowed in a cycle. However, unless the water is extremely clean, it will normally acquire enough signals for a sensible result.
- There will be an increase in the “signal noise”. Because of the difficult environment, there will be an increase in very high-velocity signals. This can bias most Doppler data beyond the ability of the signal analysis process to extract meaningful velocities.

17.13. Velocities Too Slow to Measure

When velocities fall below the minimum level the Doppler can measure (21mm/sec), signals are not processed. However, under certain conditions, the signal noise is processed, a messy signal is interpreted and a higher velocity results. Usually, the processed spread is too large. Using the filter will prevent most of these signals.

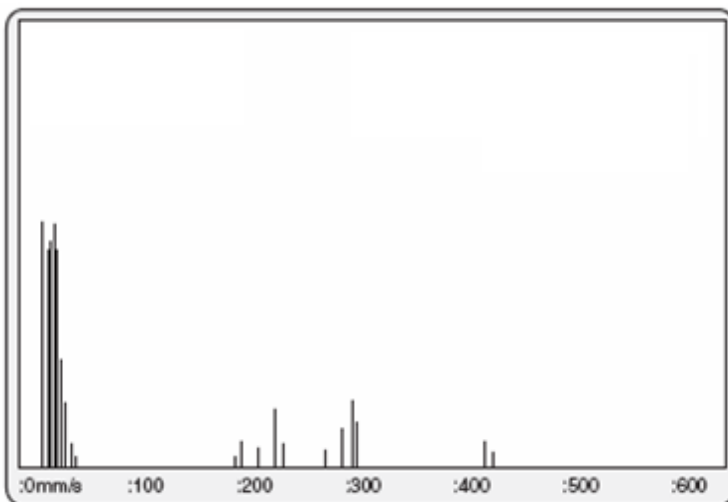

Legitimate velocity - some noise

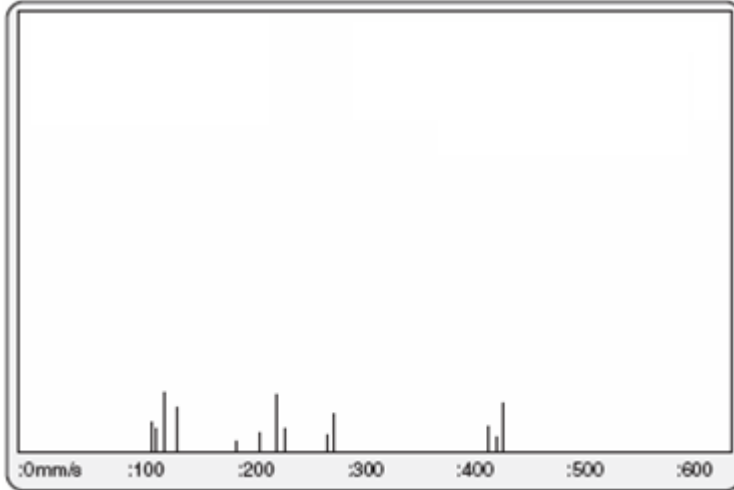

Velocity too slow - only noise remaining.

17.14. Measuring Velocities in Very Shallow Water

Poor quality velocity data will result if the water becomes so shallow that the top of the eyes of the transducer comes out of the water. A configuration setting can be used to switch off the velocity operation of the Starflow QSD when the measured depth is so shallow that the eyes are exposed. The Velocity Trace display will be similar to that for very slow velocities.

The ultrasonic depth transducer will only measure depths that are 40mm above the ultrasonic eye, and the pressure transducer will measure down to 0mm. If it is important that these very low flows be measured, then the Starflow QSD can be fitted into a narrow channel or recessed into the bed such that all the Starflow QSD is underwater whenever flow occurs.

17.15. Interference to the Transducers

It is inevitable that bed-mounted instruments will become layered with silt or algae. They may sometimes be affected by siltation or debris. The following effects have been noticed.

17.15.1. Silt, Algae and Other Soft, Saturated Materials

When covering the transducers with a 1-2mm thick layer, they appear to have little effect on the signals logged. Provided the material is flexible and saturated, the ultrasonic signals can be transmitted and received through it.

17.15.2. Burying the Transducer in Sand

Part-buried sensors continue to operate. Provided some parts of both velocity sensors are above the sand level, the velocity recorded is the same as if the sensor was clear.

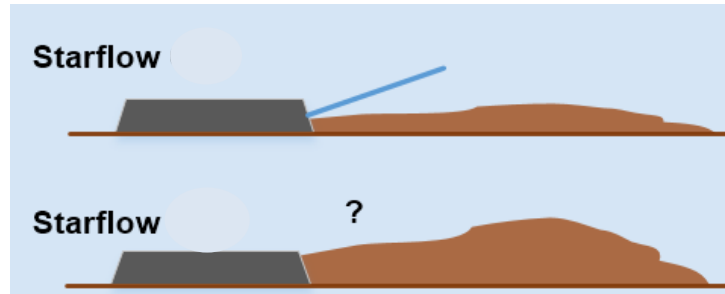

Completely buried sensors result in the signal collapsing. The signal does not appear to escape from beneath the sand to interrogate the water above.

The following histogram is typically seen.

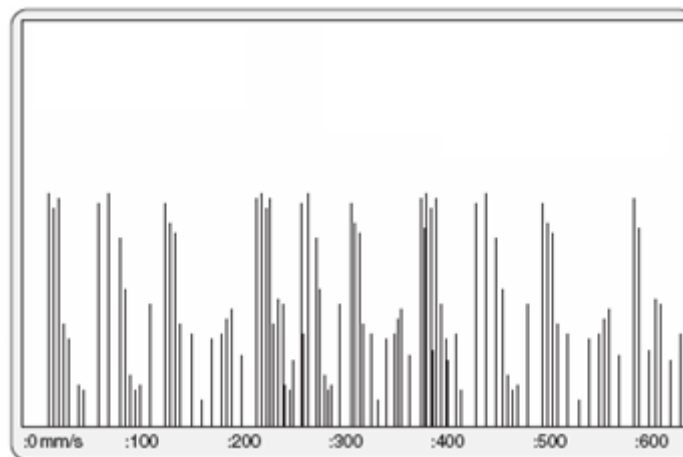

17.15.2.1. Debris on the Sensors

A similar effect to saltation can result from leaves and fine debris covering the sensors.

If the sensors are partly clear, the recording is not affected. However, one leaf lying across the two velocity sensors is enough to corrupt the signals and produce the type of histogram produced from a buried sensor.



17.15.2.2. Disruption of the Flow Pattern by Debris

Larger debris in the vicinity may affect the logged values by changing the velocity distribution in the field of view of the sensor.

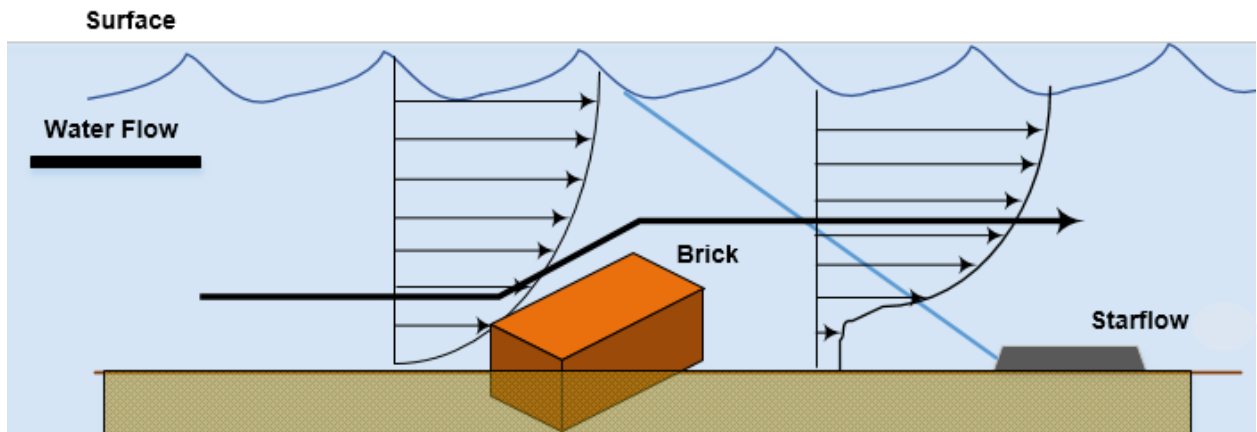

The flow distribution in the channel may no longer be laminar, and the relationship between the logged and mean channel velocity may be distorted.

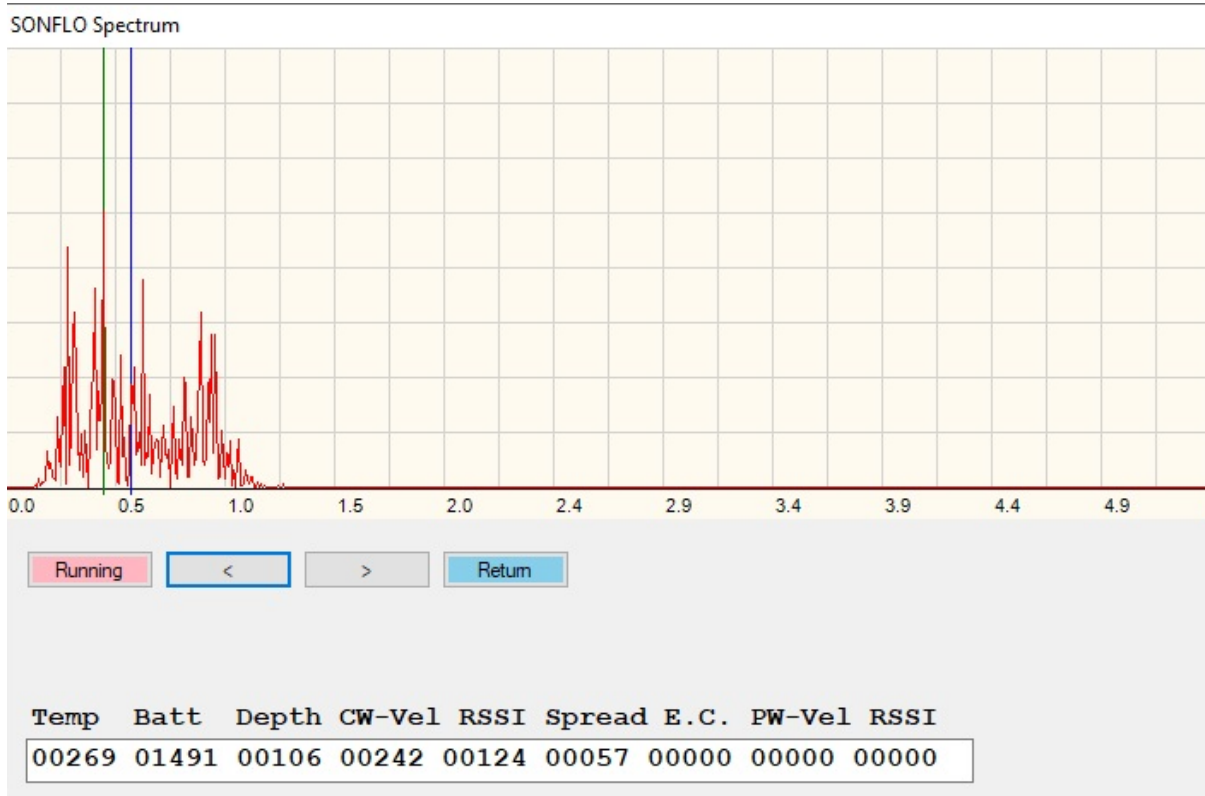

17.15.2.3. Blocking of the Signal Paths by Objects

One strategically placed solid object, such as a rock, stick or other acoustically opaque material, may block the path to either sensor, blanketing any signals. Zero signals will be dominant; however, those below 20 mm/sec. are discarded. The histogram will be distorted and have a characteristic vertical face at 20 mm/sec.

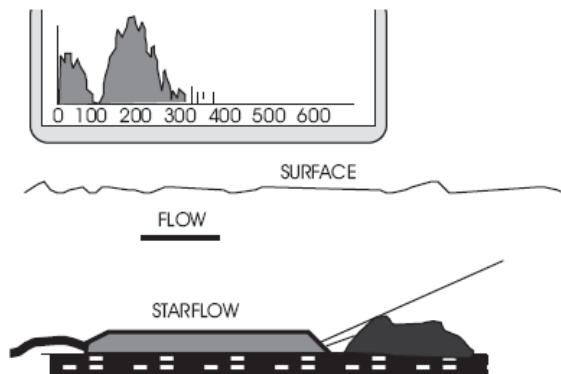

17.16. Initialise

The **Initialise** function will conduct a memory reset on the logger unit, erasing all logged memory. The scheme will need to be re-loaded.

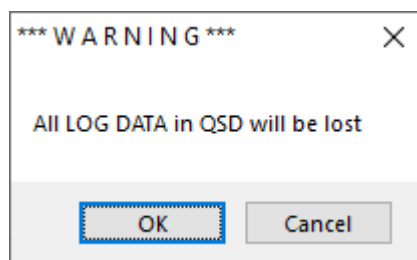

17.17. Configure

The **configure** function allows direct access to the settings, which is described in [section 11.3](#)



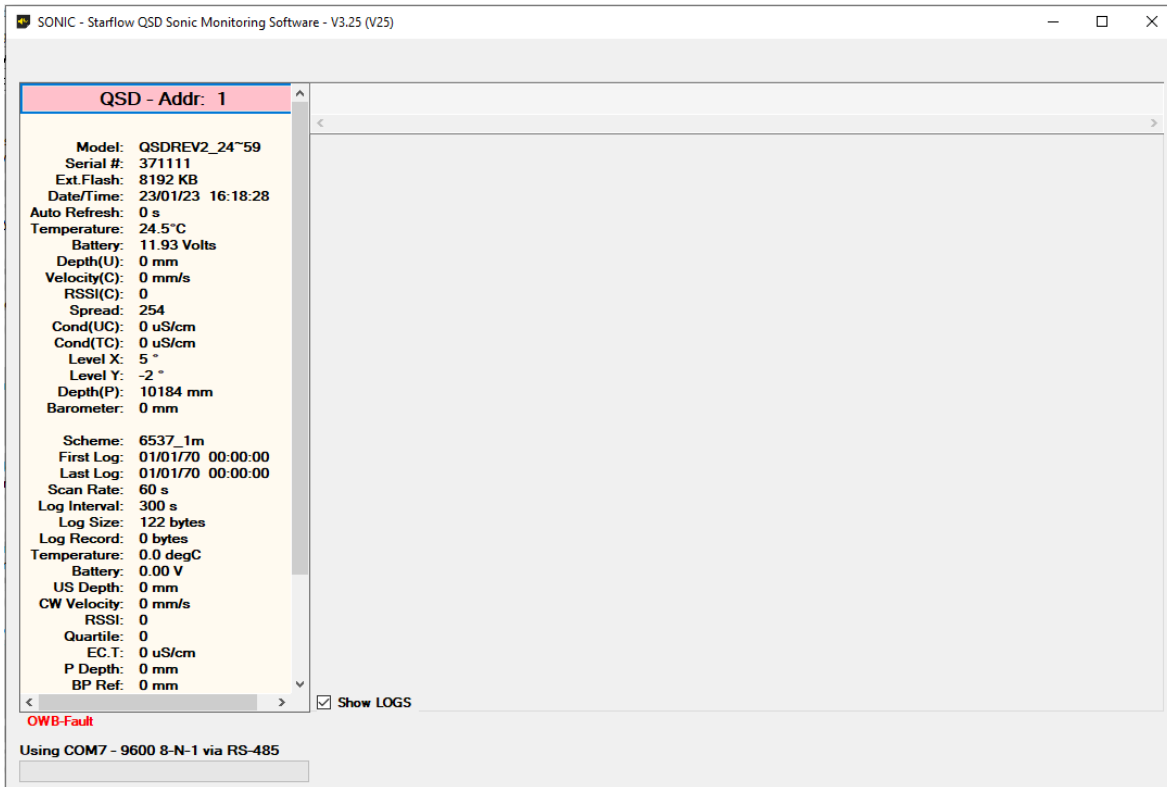

17.18. Upgrade Firmware

The **Upgrade Firmware** function allows you to upgrade the internal firmware of the Starflow QSD logger.



Upgrade Firmware: Click to upgrade. You will then need to select the file, which will only be provided by the Unidata support team. When the firmware file is selected, the software will advise that all data that is on the logger will be erased. The Upgrade will then begin and advise when completed.

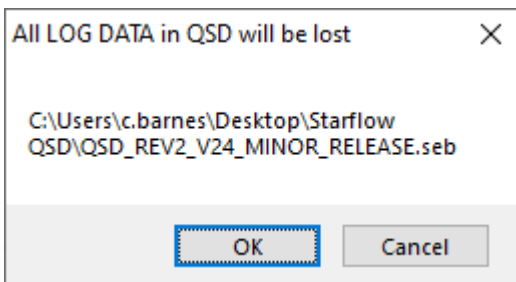

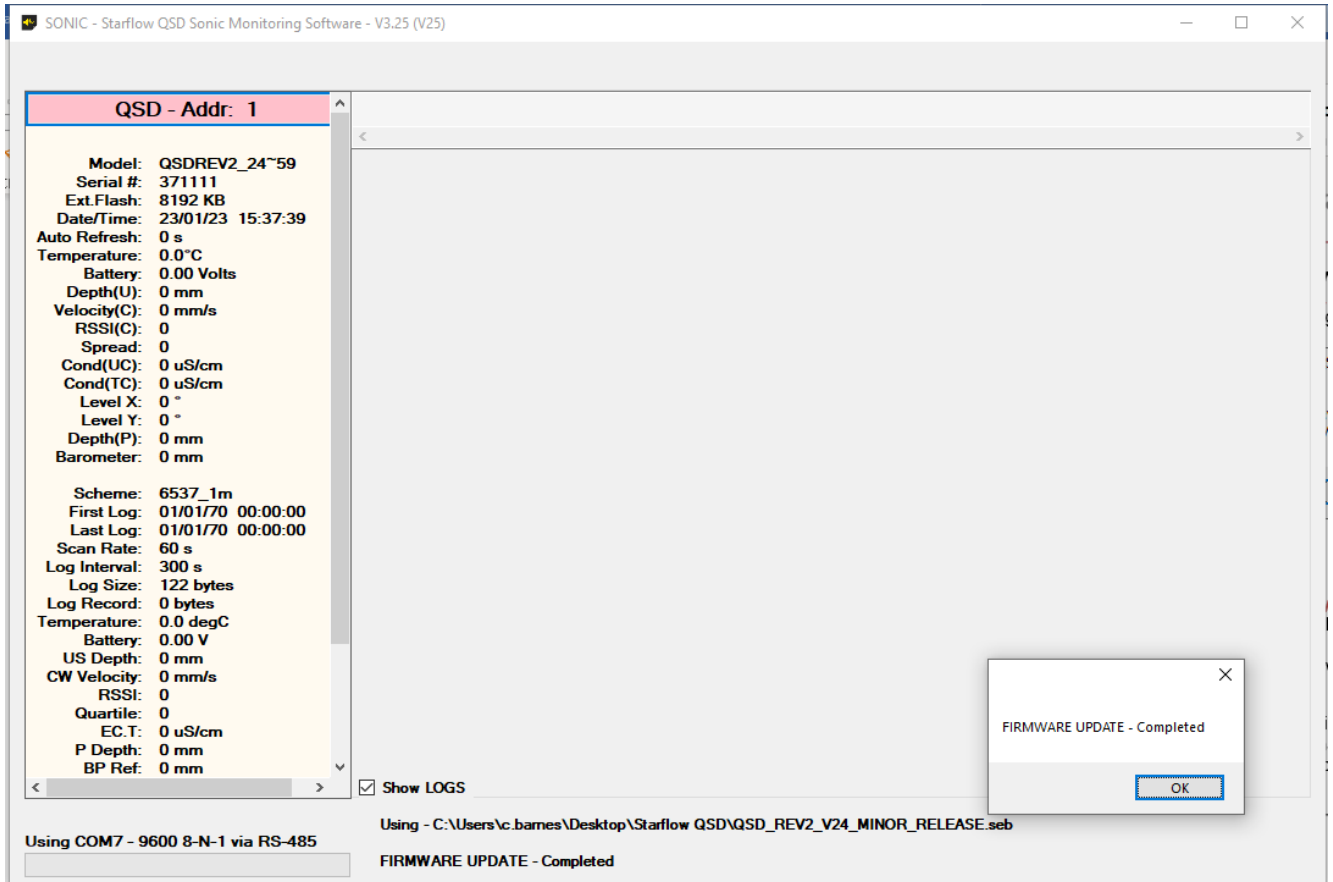

QSD - Addr: 1

Model: QSDREV2_24~59
Serial #: 371111
Ext.Flash: 8192 KB
Date/Time: 23/01/23 15:37:39
Auto Refresh: 0 s
Temperature: 0.0°C
Battery: 0.00 Volts
Depth(U): 0 mm
Velocity(C): 0 mm/s
RSSI(C): 0
Spread: 0
Cond(UC): 0 uS/cm
Cond(TC): 0 uS/cm
Level X: 0 °
Level Y: 0 °
Depth(P): 0 mm
Barometer: 0 mm

Scheme: 6537_1m
First Log: 01/01/70 00:00:00
Last Log: 01/01/70 00:00:00
Scan Rate: 60 s
Log Interval: 300 s
Log Size: 122 bytes
Log Record: 0 bytes
Temperature: 0.0 degC
Battery: 0.00 V
US Depth: 0 mm
CW Velocity: 0 mm/s
RSSI: 0
Quartile: 0
EC.T: 0 uS/cm
P Depth: 0 mm
BP Ref: 0 mm

Show LOGS

Using COM7 - 9600 8-N-1 via RS-485

Using - C:\Users\c.barnes\Desktop\Starflow QSD\QSD_REV2_V24_MINOR_RELEASE.seb

FIRMWARE UPDATE - Completed

FIRMWARE UPDATE - Completed