

Operating Instructions  
**Parsivel Application Software**  
**ASDO**

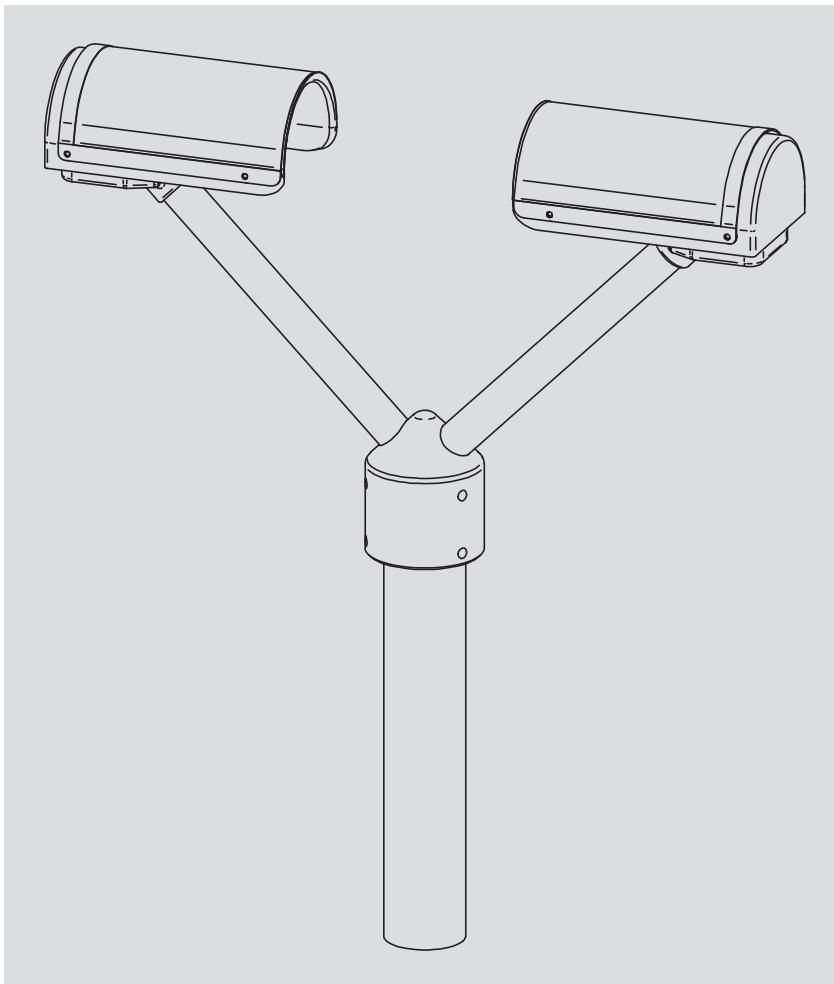

We reserve the right to make technical improvements!

## Table of Contents

<b>1 Introduction</b>	<b>4</b>
<b>2 Installation</b>	<b>5</b>
2.1 Connecting the Parsivel to the PC	5
2.2 Installing ASDO	5
2.3 Starting ASDO for the first time	6
<b>3 Configuring the Parsivel</b>	<b>7</b>
3.1 Set system parameters	8
3.2 Configuring the telegram setup	10
<b>4 Displaying data in Online Mode</b>	<b>11</b>
4.1 Starting Online Mode	11
4.2 Storing measured values in a database	12
4.3 Displaying current weather	12
4.4 Representing measurement data in the precipitation spectrograph	13
4.5 Displaying current measurement status	15
4.6 Displaying static Parsivel information	15
4.7 Representing measurements in the time sequence graph	16
<b>5 Displaying data in Offline Mode</b>	<b>18</b>
5.1 Starting Offline Mode	18
5.2 Displaying current weather	18
5.3 Representing measurement data in the precipitation spectrograph	19
5.4 Displaying current measurement status	20
5.5 Displaying static Parsivel information	20
5.6 Representing measurements in the time sequence graph	21
<b>6 Setting ASDO options</b>	<b>22</b>
6.1 Setting database options	22
6.2 Setting export options	23
<b>7 Updating Parsivel firmware</b>	<b>27</b>

## 1 Introduction

The Parsivel ASDO software makes it very easy to configure the Parsivel, read out data and display it. The software is available in the following versions:

- ▶ ASDO Basic  
Just application software, without database
- ▶ ASDO  
Full version with integrated database

ASDO is tailored especially to read out and configure the OTT Parsivel and supports the following functions:

- ▶ Online collection of Parsivel data sets
- ▶ Visualization of particle distribution
- ▶ Time sequence graph of precipitation intensity and other parameters
- ▶ Integrated database (not in the basic version)
- ▶ Automatic export in text format (for example to OTT Hydras 3)
- ▶ Configuration of the OTT Parsivel

## 2 Installation

### 2.1 Connecting the Parsivel to the PC

Since the Parsivel is equipped with an RS-485 interface and common PC's use standard RS-232 or USB interfaces, the Parsivel must be connected to the respective PC through a corresponding interface adapter.

### 2.2 Installing ASDO

Proceed as follows to install the Parsivel ASDO software:

- End all applications before you run the Setup program.
- Insert the ASDO CD-ROM into the CD drive of your PC.
- Open the appropriate language folder on the CD and start by double-clicking on the file "setup.exe" contained therein.  
The program "setup.exe" starts the installation assistant, which leads you through the rest of the installation process.
- Follow all messages given by the installation assistant and input the required information when asked:
  - Target directory for the installation
  - Program folder
  - User informationEach time you press the "Next" button, you are directed to the next window.
- In the last window, check your inputs once more and start the copying process by clicking on the "Next" button.  
The Setup program copies all required files into the selected directory of your PC.
- End the Setup program.

### 2.3 Starting ASDO for the first time

Proceed as follows to start the Parsivel ASDO software for the first time:

- Start ASDO (for example Windows Start menu "Programs | ASDO"). The software starts and the "ASDO Licensing" window opens.

Fig. 1: Inputting the License Key in the "ASDO Licensing" window.



- If you have the full version of ASDO with integrated database, input the licensing key into the input field and confirm by clicking on the "OK" button. The license key can be found in the CD booklet.  
If you have the ASDO Basic software without the database, click on the "Cancel" button without entering a license key.  
The next time ASDO is started, the key request no longer appears.

If you would like to enter the license key later, proceed as follows:

- Start ASDO.
- Select the "File | Register full version" menu. The "ASDO licensing" window opens.
- Enter the license key in the input field and confirm by clicking on the "OK" button. The full version can now be used.

### 3 Configuring the Parsivel

You can configure Parsivel system parameters and telegram setup. To do so, proceed as follows:

- Connect the Parsivel to your PC as described in the operating instructions “Present Weather Sensor Parsivel”.
- Start the Parsivel ASDO software on your PC.
- Select the “Configuration” tab:

Fig. 2: “Configuration” tab.

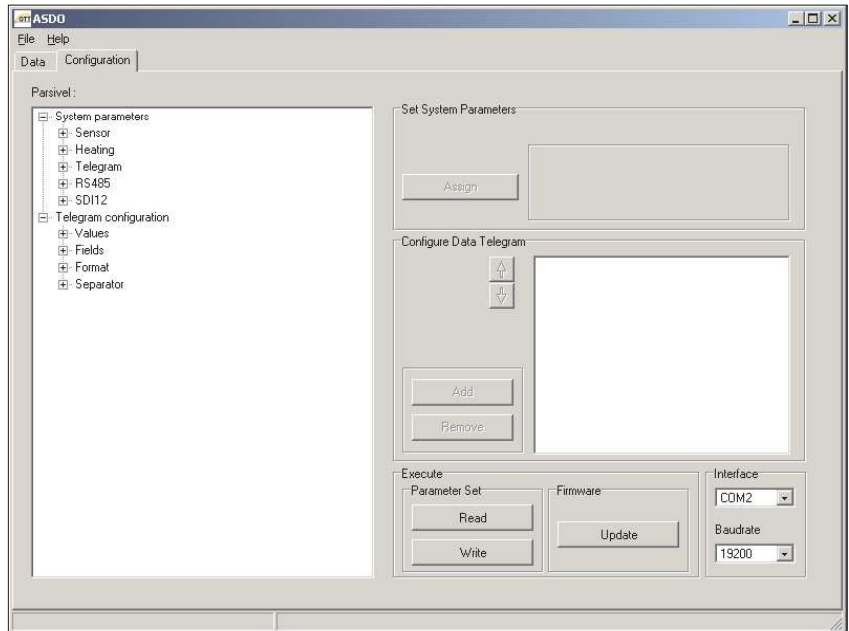

- Enter the interface on your computer to which the Parsivel is connected under “Interface”.
- Enter the value of the baud rate of your connection under “Baud Rate”.
- Make sure that Online Mode is stopped in the “Data” tab, since otherwise the COM-Port is active (see Chapter 4.1).
- Click on the “Read” button. The data of the connected Parsivel are read in and displayed in the left window as a tree diagram.

### 3.1 Set system parameters

To set the system parameters, proceed as follows:

- Click on the parameter in the tree diagram that you wish to change. The field "Set System Parameters" indicates the corresponding settings that are available.
- Enter the desired value and confirm this input by clicking on the "Assign" button. The respective parameter is changed.
- Proceed in the same manner for all other parameters to be changed.
- Store the changes in the Parsivel by clicking on the "Write" button.

The system parameters are defined as follows:

#### Sensor

Station ID	Alphanumeric name of the station, 10-place input.
Sensor ID	Alphanumeric name of the sensor, 4-place input.
Setup date	Coordinated with the PC, cannot be manually set.
Setup time	Coordinated with the PC, cannot be manually set.
Measuring interval /sec	Indicates the sampling interval at which the Parsivel automatically sends measurement data.
Pollmode	If the polling mode is activated, ASDO reads the measured values from the Parsivel. The sampling interval entered in the "Data" tab applies here (see Chapter 8 "Displaying Data in Online Mode").

#### Heating

Mode	This mode can be set within the value range of 0 ... 2: 0 = Heater turned off 1 = Heater automatically regulates the power supply within the range $I_{min}$ to $I_{max}$ to protect against ice buildup (see operating instructions "Present Weather Sensor Parsivel"). 2 = Heater constantly running at $I_{max}$
Max. Current in A/100	Configuring $I_{max}$
Min. Current in A/100	Configuring $I_{min}$
Switching temperature / °C	Configuring the minimum temperature. If the temperature drops lower than this, the heater turns on. The prerequisite for this is that Mode = 1.

#### Telegram

Usertelegram	The user telegram is configured through the telegram setup (see Chapt. 6.2 "Configuring the Telegram Setup"). If the user telegram is active, the measured values are output according to the user telegram. If it is inactive, the measured values are output in a predefined standard telegram.
Telegram	All parameters and formatting that had been defined for the user telegram are displayed here with formatting strings (see operating instructions "Present Weather Sensor Parsivel" Chapter 8, "Operating the Parsivel with a Terminal Software Package"). This list is read-only and cannot be changed here.



**RS-485**

Baudrate

Configuring the baud rate. In order to run in Online Mode, a baud rate of 19200 must be set.

4-Wire Mode

Activation/deactivation of 4-wire mode

Busmode

Activation/deactivation of bus mode

Bus address

Bus address configuration

**SDI 12**

Mode

Activation/deactivation of the SDI-12 connection

Bus address

Bus address configuration

### 3.2 Configuring the telegram setup

This is where you can configure the telegram setup any way you wish. The following values are available to you:

Fig. 3: Configuring the telegram setup.

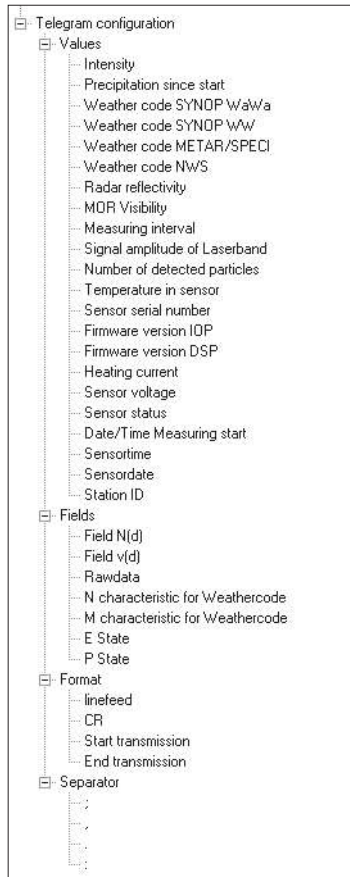

To put together your individual telegram from this selection, proceed as follows:

- Mark the value in the tree diagram that you would like to include in the telegram.
- Click on the "Add" button. The marked value is included in the right selection window.
- Proceed in the same manner for all other values that you would like to include.
- To change the order of included values in the right selection window, mark the corresponding values and change their position using the red arrow keys.
- To delete a value from the selection window, mark the corresponding value and click on the "Remove" button.
- Store the completed telegram setup in Parsivel by clicking on the "Write" button.

**Note:**

Every change in the telegram setup is also recorded in the formatting string in the "System parameters | Telegram | Telegram" branch.

## 4 Displaying data in Online Mode

In the Online Mode, ASDO displays the currently measured values of the connected Parsivel. The display is updated at every sample. The Online Mode is not dependent on the database, and therefore can be used with any ASDO version. To do so, a baud rate of 19200 must be set in the configuration (see Chapt. 3.1 "Set System Parameters")

### 4.1 Starting Online Mode

To start Online Mode, proceed as follows:

- Select the "Data" tab in the start window.

Fig. 4: "Data" tab. The Online Mode is selected and active.

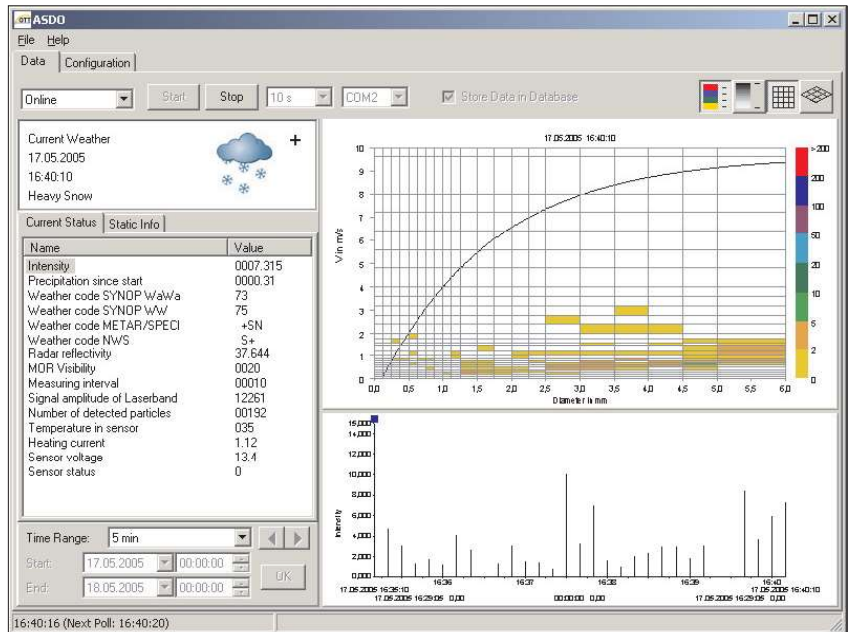

- Select the "Online" option in the options bar.
- From the options bar, select the COM port through which the Parsivel is connected to your PC.
- Select the sampling interval from the options bar at which ASDO is to accept measured values from the Parsivel.

#### Note:

- ▶ This setting can only be made if Online Mode data transfer is deactivated by "Stop".
- ▶ Make sure that the poll mode is activated in the configuration (see Chapt. 3 "Configuring the Parsivel"). If it is deactivated, Parsivel actively sends its data at the period set in the configuration.
- ▶ The sampling interval does not coincide with the time when the communication starts, but rather with the PC clock.

Example:

Sampling interval = 10 minutes

If communication is started at 14:04:32, ASDO transfers the first measurement at 14:10:00.

- ▶ The current clock time and the time of the next measurement sample are displayed in the left field of the ASDO status line.

- Click on the "Start" button in the options bar.  
ASDO will transfer the data from the Parsivel at the next polling interval.

## 4.2 Storing measured values in a database

The full version of ASDO contains a database to which the polled measured values can automatically be sent. In order to store measured values in the database, the Station ID must have been defined in the configuration (see Chapt. 4 "Set System Parameters") In order to store measured data from Online Mode in a database, proceed as follows:

- Activate the "Store Data in Database" option in the options bar with . All current measured values will automatically be sent to the database.

### Note:

If you have the ASDO Basic Parsival software or if the "Store Data in Database" option is not activated, ASDO stores the data in Online Mode in a circular buffer that can collect up to 86,400 values per parameter. For example, at a polling interval of 10 seconds, approximately 10 days worth of data can be collected and filed. As soon as the circular buffer is full, the oldest data are written over. If the Parsivel's ASDO software is closed, the data on the circular buffer are deleted. The data on the circular buffer can not be displayed in Offline Mode.

## 4.3 Displaying current weather

Fig. 5: Displaying the current weather.



In this frame,

- the date
- the time
- and the weather conditions, in words and pictorially

are displayed for the currently polled measurement. The data are updated each time a new measurement is read out.

"+" signifies a state of heavy precipitation

"-" signifies a light state of precipitation

## 4.4 Representing measurement data in the precipitation spectrograph

Fig. 6: Precipitation spectrograph.

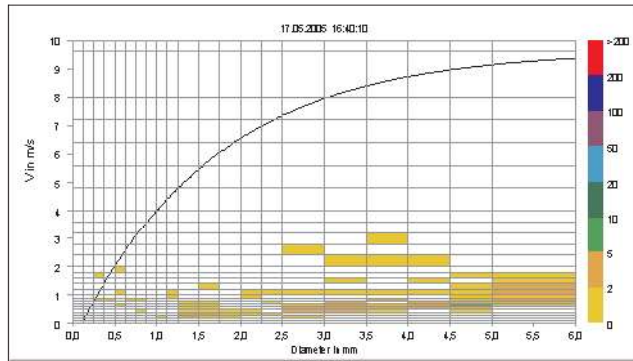

The X-axis of the precipitation spectrograph is subdivided into 32 diameter classes and the Y-axis is subdivided into 32 velocity classes for precipitation particles. The Gunn-Kinzer curve is the reference curve, which is always shown in the spectrograph.

Parsivel determines the diameter and rate of fall of each precipitation particle. ASDO classifies the particles in the spectrograph according to these parameters. Depending on the number of detected particles, the display is colored accordingly.

This precipitation spectrograph is also updated in Online Mode with every newly read out data set.

The dimensional and the color representation of the spectrograph can be changed through four buttons on the options bar:



Display color. Every particle class is assigned a color. Example: In Figure 6, a green marking means that Parsivel has detected between 5 and 10 precipitation particles.



Display in shades of gray. Display by means of gray shading is continuous. The darker the fields are marked, the more precipitation particles were detected.



2-dimensional representation of the spectrograph.



3-dimensional representation of the spectrograph, only functional in the full ASDO version.

### Note:

- ▶ To obtain the precise number of particles of a field in the precipitation spectrograph, point the mouse pointer to the desired field. The number of particles is output in the right field of the status row.
- ▶ To zoom the spectrograph in the X- or Y-axis, click in the spectrograph with the mouse pointer and draw it to the desired size.

### Editing the colored column

The color assignment and division of upper boundaries of classes can be set as follows:

- Click on the colored column to the right of the spectrograph.  
The "Particle Classes" window opens:

Fig. 7: "Particle Classes" window to determine the upper boundary of the class and to define the color column.

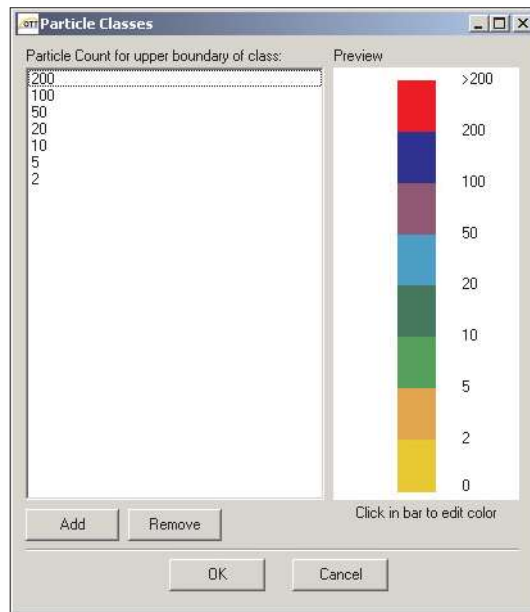

- To add a new upper boundary class, click on the "Add" button. The "Add Particle Class" window opens.

Fig. 8: "Add Particle Class" window. Entry for the value of the class boundary.

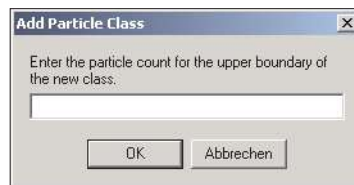

- Enter the desired upper boundary of the class and confirm your input with "OK". The class boundary will be created with the standard color black.
- To edit the color of the class boundary, click in the "Preview" frame of the "Particle Class" window on the corresponding color. The "Color" window opens. Select an arbitrary color and confirm your choice with "OK".

## 4.5 Displaying current measurement status

Fig. 9: "Current Status" tab.

Current Status		Static Info
Name	Value	
Intensity	0007.315	
Precipitation since start	0000.31	
Weather code SYNOP WaWa	73	
Weather code SYNOP WW	75	
Weather code METAR/SPECI	+SN	
Weather code NWS	S+	
Radar reflectivity	37.644	
MDR Visibility	0020	
Measuring interval	00010	
Signal amplitude of Laserband	12261	
Number of detected particles	00192	
Temperature in sensor	035	
Heating current	1.12	
Sensor voltage	13.4	
Sensor status	0	

In the "Current Status" tab, all dynamic parameters and associated current values are displayed. These are updated with every new poll. To display these values graphically, proceed as follows:

- In the "Current Status" tab, click on the parameter that you wish to graphically display.  
Its graphical representation appears in the time sequence graph. The time frame corresponds to the settings from the "Time Frame" frame (see Chapter "Time Sequence graph" and "Time Range").

## 4.6 Displaying static Parsivel information

Fig. 10: "Static Info" tab.

Current Status		Static Info
Name	Value	
Sensor serial number		
Firmware version IOP	V1.01	
Firmware version DSP	V1.01	
Date/Time Measuring start	12:42:16 06.05...	
Sensortime	13:08:35	
Sensordate	06.05.2005	
Station ID	Parsivel08	
Sensor ID	1234	

All static system settings of the connected Parsivel are displayed in the "Static Info" tab.

## 4.7 Representing measurements in the time sequence graph

Fig. 11: Time sequence graph display.

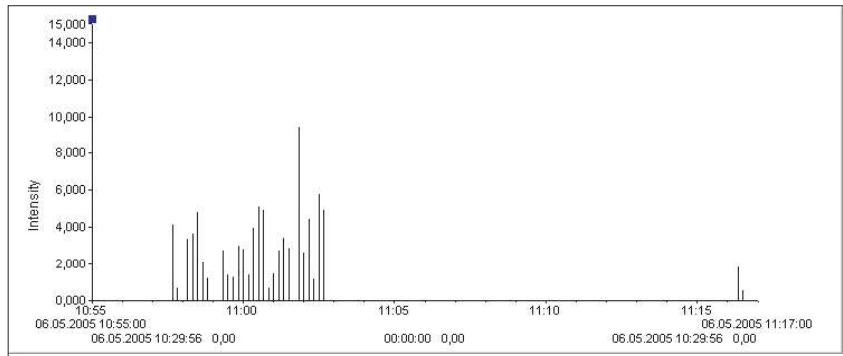

The values of the parameter that is selected in the "Current Status" tab are shown graphically in the time sequence graph. The following parameters can not be shown graphically:

- ▶ Weather Code SYNOP ww
- ▶ Measurement interval
- ▶ Sensor status

The parameter that is currently displayed is to the left in the time sequence graph next to the Y-axis. The time range shown coincides with "Time Range" settings. The following values are output below the X-axis in two rows:

### Upper row

To the left, the date and time of start is indicated, and to the right the date and time range is indicated. If a numerical time range was selected, ASDO updates the date and time info according to the polling interval.

### Lower row

In the lower row to the left, the date, time and numerical value of the measurement where the left ruler is positioned are output, and on the right are the same parameters for the right ruler. The difference of the two time values and the two measurements is displayed between these two displays.

### Rulers

You have two rulers at your disposal in the time sequence graph. In order to quickly position the rulers using the mouse, they have a square mark at their upper end. To shift a ruler, click on this mark and move the ruler while holding down the mouse key. After releasing the mouse key, the ruler jumps to the next measurement. The mark of the currently active ruler is green and that of the inactive ruler is blue. The active ruler can also be moved with the cursor key.



## Setting the time range of the time sequence graph

Fig. 12: Setting the time range of the time sequence graph.

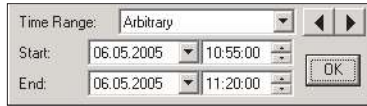

In the "Time Range" frame, the display range of the time sequence graph can be adjusted. The following time ranges are possible:

- ▶ Arbitrary
- ▶ 5 min
- ▶ 15 min
- ▶ 30 min
- ▶ 60 min
- ▶ 2 h
- ▶ 6 h
- ▶ 12 h
- ▶ 24 h
- ▶ 2 d
- ▶ 7 d
- ▶ 14 d
- ▶ 30 d

Proceed as follows to set the time range:

- Select the desired time range in the "Time Range" selection window.

### Selecting "Arbitrary" as the time range

If you would like to more precisely view a desired time range in the time sequence graph, select "Arbitrary" as the time range. ASDO continues to receive all updated values at the polling interval setting, but the time sequence graph remains locked onto the selected time range.

Proceed as follows to set the time range to "Arbitrary":

- Select the "Arbitrary" time frame option.
- Input the date and time for the start and end of the time range. You can either directly mark the individual positions of the date and time fields and overwrite them or you can edit the values using the black arrows in the selection fields.
- Click on the "OK" button.
- To display the previous or following time range with the same interval, click on the corresponding arrow key.

### Selecting a predefined Time Range

If you select one of the predefined time ranges from the selection list, it is always displayed in the time sequence graph beginning with the most recent value and extending into the future. As soon as a new value is polled, this time frame shifts into the future by the polling interval selected.

Proceed as follows to set a numerical time range:

- Select the desired predefined time range in the selection list.  
The time sequence graph is adjusted immediately after the selection.

## 5 Displaying data in Offline Mode

The Offline Mode is only available in the full ASDO version with database. In this mode, the data stored in the database can be displayed by all Parsivels connected previously.

### 5.1 Starting Offline Mode

To start Offline Mode, proceed as follows:

- Select the "Data" tab in the ASDO start window.

Fig. 13: "Data" tab. Offline Mode is selected.

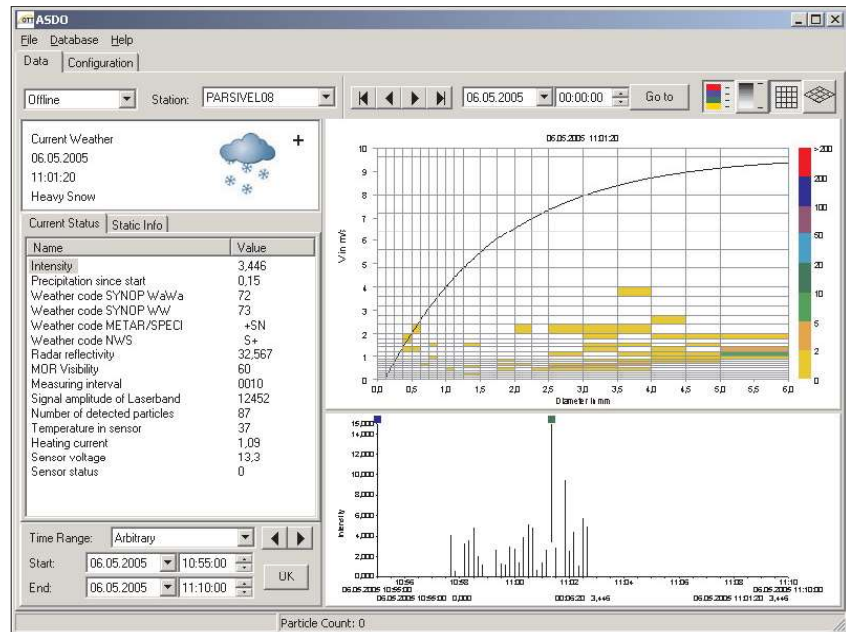

- Select the "Offline" option in the options bar.
- In the options bar, select the station whose value you wish to display.

### 5.2 Displaying current weather

Fig. 14: Displaying the current weather.



In this frame,

- the date
- the time
- and the weather conditions, in words and pictorially

are displayed for the measurement that is selected either in the precipitation spectrograph or using the ruler in the time sequence graph. See the other chapters in this regard as well.

### 5.3 Representing measurement data in the precipitation spectrograph

Fig. 15: Precipitation spectrograph in Offline Mode.

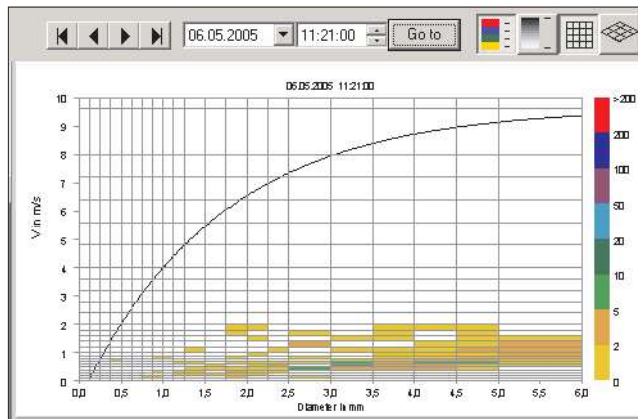

See Chapter 4.4 of these operating instructions for a general description of the precipitation spectrograph.

To display in the precipitation spectrograph a particular measurement from the database of the selected Parsivel, proceed as follows:

- Enter the date in the left selection field above the spectrograph and in the right selection field enter the time at which you would like to display the measurements. You can either directly mark the individual positions of the date and time fields and overwrite them or you can edit the values using the black arrows in the selection fields.
- Click on the "Go To" button.
- To display the measurement directly before or after, click on the ◀ or ▶ key. In order to display the first or last stored measurement from the measurement sequence of a Parsivel, click on the ◀◀ or ▶▶ key.

**Note:**

- ▶ When a measurement is selected, the corresponding data is output in the "Current Weather" window and in the "Current Status" tab. Also, the ruler in the time sequence graph is set to this measurement.

## 5.4 Displaying current measurement status

Fig. 16: "Current Status" tab.

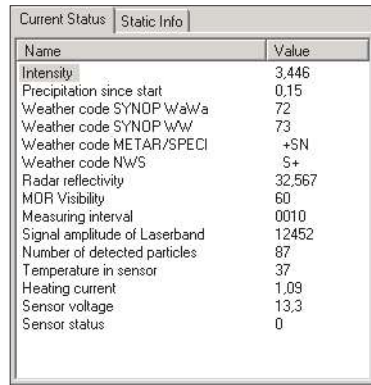

Name	Value
Intensity	3.446
Precipitation since start	0.15
Weather code SYNOP WwWw	72
Weather code SYNOP WW	73
Weather code METAR/SPECI	+SN
Weather code NWS	S+
Radar reflectivity	32.567
MOR Visibility	60
Measuring interval	0010
Signal amplitude of Laserband	12452
Number of detected particles	87
Temperature in sensor	37
Heating current	1.09
Sensor voltage	13.3
Sensor status	0

In the "Current Status" tab, the dynamic parameters and the associated value of the selected Parsivel are displayed for the time range that had been entered through the precipitation spectrograph or had been selected in the time sequence graph using the ruler.

## 5.5 Displaying static Parsivel information

Fig. 17: "Static Info" tab.

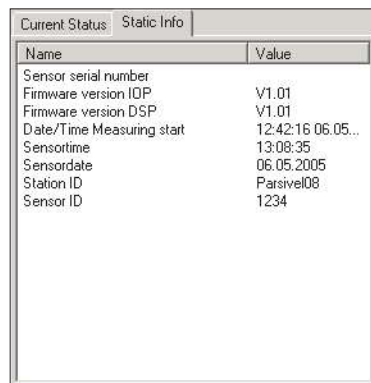

Name	Value
Sensor serial number	
Firmware version IDP	V1.01
Firmware version DSP	V1.01
Date/Time Measuring start	12:42:16 06.05...
Sensortime	13:08:35
Sensordate	06.05.2005
Station ID	Parsivel08
Sensor ID	1234

All static system settings of the Parsivel selected in the options bar are displayed in the "Static Info" tab.

## 5.6 Representing measurements in the time sequence graph

Fig. 18: Time sequence graph display.

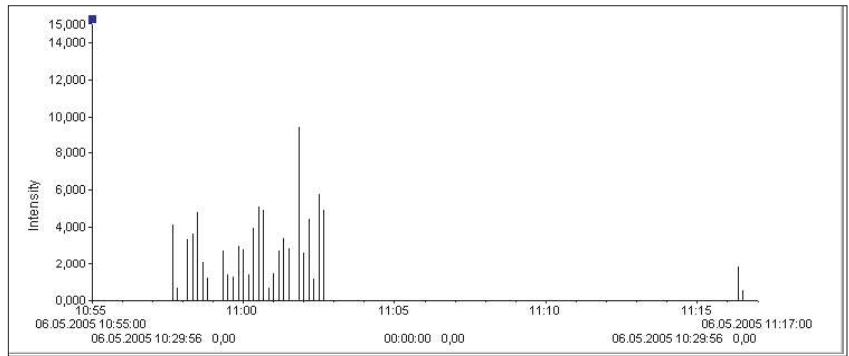

The values of the parameter that is selected in the "Current Status" tab are shown graphically in the time sequence graph. The time range in the display corresponds to the setting in the "Time Range" frame (see Chapter 4.7). The parameter that is currently displayed is to the left in the time sequence graph next to the Y-axis.

The following values are output below the X-axis in two rows:

### Upper row

To the left, the date and time of start is indicated, and to the right the date and time range is indicated.

### Lower row

In the lower row to the left, the date, time and numerical value of the measurement where the left ruler is positioned are output, and on the right are the same parameters for the right ruler. The difference of the two time values and the two measurements is displayed between these two displays.

### Rulers

You have two rulers at your disposal for time sequence graph. In order to quickly position the rulers using the mouse, they have a square mark at their upper end. To shift a ruler, click on this mark and move the ruler while holding down the mouse key. After releasing the mouse key, the ruler jumps to the next measurement. The mark of the currently active ruler is green and that of the inactive ruler is blue. The active ruler can also be moved with the cursor keys. If a measurement is selected using a ruler, this measurement is also displayed in the precipitation spectrograph.

### Note:

When a specific value is marked with the ruler in the time sequence graph, the corresponding data are output in the "Current Weather" window, in the "Current Status" tab, and in the precipitation spectrograph.

## 6 Setting ASDO options

ASDO provides the following options:

- ▶ Database Options
- ▶ Export Options

### 6.1 Setting database options

You have the ability to adjust the following database options:

- ▶ Store data set only if there is precipitation  
Ignores all data sets when no precipitation has been detected.
- ▶ Store Parsivel raw data (spectrum)  
This function is the standard setting. It allows the data from the database to be displayed in the precipitation spectrograph afterward as well. If this function is activated, much more of the database's storage space is used. If this function is not activated, the data can still be displayed in the time sequence graph, but not in the precipitation spectrograph.

Proceed as follows to set the database options:

- Select the "Database" tab:

Fig. 19: "Options" window  
"Database" tab.

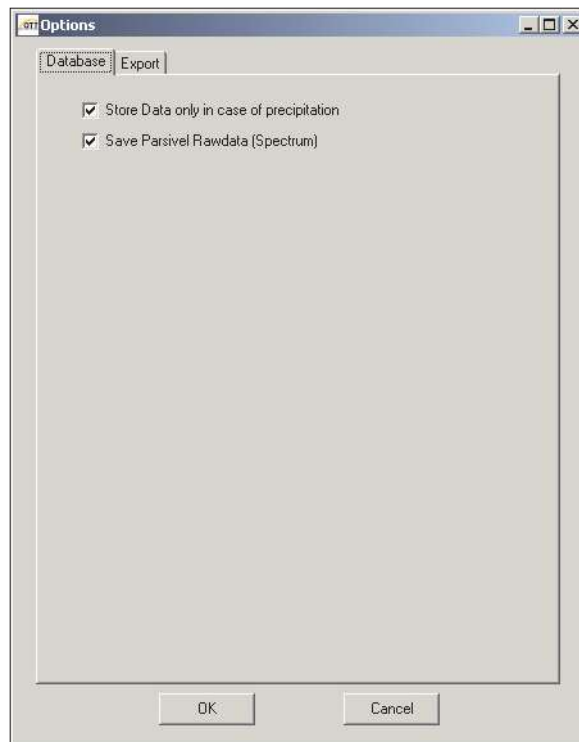

- Activate the desired settings with  and confirm with "OK".

## 6.2 Setting export options

The following export settings are available to you:

- ▶ Defining the export format
- ▶ Defining the export data
- ▶ Activating automatic export

Proceed as follows to set the export options:

- Select the "Export" tab:

Fig. 20: "Options" window  
"Export" tab.

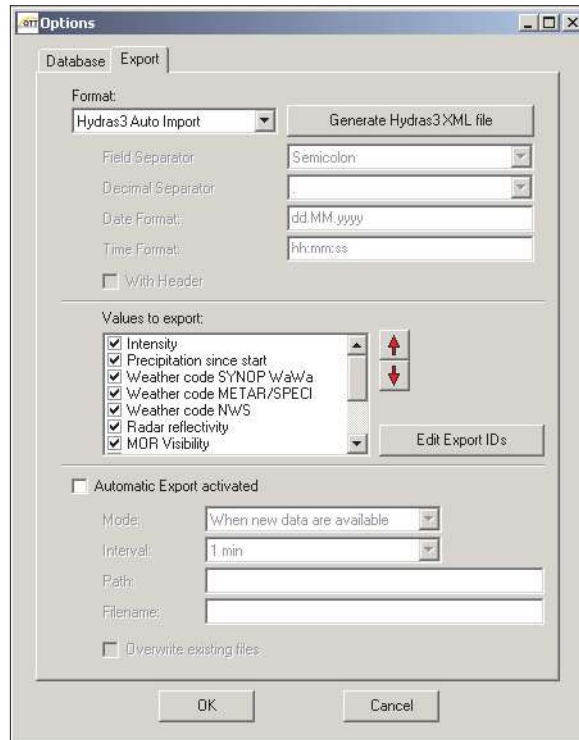

### Defining the Export Format

The following export formats are available to you:

- ▶ Hydras 3 Autoimport  
Prepares the measured data for automatic import from the Hydras 3.
- ▶ Separate columns  
Outputs the measured data as CSV data that can be opened using Microsoft Excel, for example.

Proceed as follows to define the export format:

- Select the "Export" tab:
- Select the desired export format in "Format".
- If you have selected the "Separate Columns" format, select the field separator, the decimal separator, the date format and the time format in the corresponding selection fields.
- Then, define that data that you would like to export (see "Defining Export Data").

### Defining Export Data

Under “Values to Export”, you have the ability to define that data that ASDO is to export and in what sequence this is to occur.

To define the export data, proceed as follows:

- Select the values in the selection field under “Values to Export” that ASDO is to export by clicking in the box to the left of the corresponding value.

To edit the export data sequence, proceed as follows:

- Click on the name of the corresponding value so that it is marked in blue.
- Change the position of this value using the red arrows.

To edit the Export IDs , proceed as follows:

- Click on the “Edit Export IDs” button. The “Export ID” window opens.

Fig. 21: “Export ID” window. The Export-ID of each parameter can be changed.

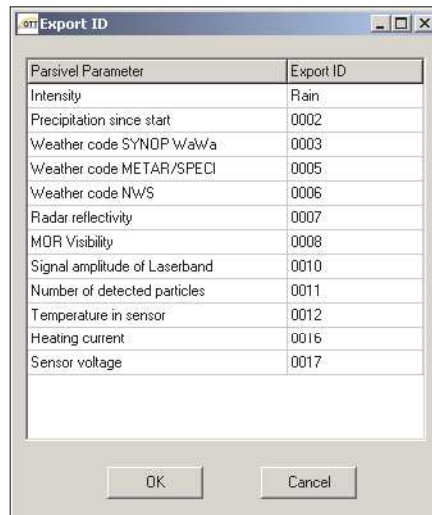

- Click on the ID number of the corresponding value and change it. The ID must not be longer than 4 places. Input is alphanumeric. The ID number that you determine here corresponds to the sensor number in the Hydras 3 application software.



## Activating Automatic Export

This function allows you to automatically export to a database the values that ASDO retrieves from Parsivel. To do so, proceed as follows:

- Activate "Automatic Export activated" with .
- Select the desired mode:
  - ▶ When new data becomes available  
Exports only when new data has been collected
  - ▶ Cyclical  
Exports data at a determined interval
- Enter the desired interval for the "Cyclical" mode for automatic exporting.
- Enter the path for the database to which the values are to be exported.
- Enter an export file name. To issue an individual name for each export file, you can define the file name from variables:
  - <DATE> includes the date of the measurement in the file names.  
Form: YYYYMMPP
  - <TIME> includes the time of the measurement in the file names.  
Form: HHMMSS
  - <STATION> includes the station name in the file names.Give the file name the ending ".MIS".
- If you would like to overwrite the data in the selected file, select "Overwrite Existing Files" with .

Fig. 22: Automatic Export settings.

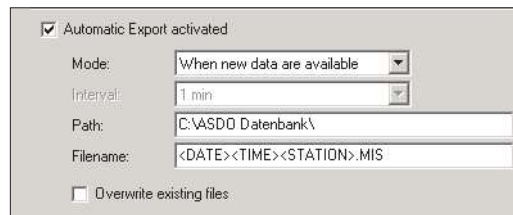

The screenshot shows a dialog box titled "Automatic Export settings". It contains the following fields and options:

- Automatic Export activated
- Mode:
- Interval:
- Path:
- Filename:
- Overwrite existing files

### Note:

If you would like to combine the automatic exporting of data from ASDO with the automatic import function of Hydras 3, make sure that the export and import paths agree.

### **Automatically exporting measurements from ASDO to Hydras 3**

To export Parsivel measurements from ASDO to Hydras 3, a corresponding station must be created in Hydras 3 including sensors for the Parsival measurement. You have the ability to manually create this measuring station in Hydras 3 (see Hydras 3 Online Help) or in a simpler manner to export the desired measurement configuration from ASDO as an XML file. This, in turn can be imported to Hydras 3.

To do so, proceed as follows:

- Select the "Export" tab in the "Options" window.
- Select the "Hydras 3 Auto Import" format.
- Define the values to be imported.
- Confirm the configuration with "OK".
- Reopen the "Options" window and select the "Export" tab. The configuration that you defined in the previous steps is already in place.
- Now, click on the "Generate Hydras 3 XML File" button. A window with the same name opens.
- Enter the Station ID of the corresponding Parsivel in this window and confirm your entry with "OK". The "Save as" window opens.
- Enter a file name for the XML file and select the directory in which the file is to be saved.
- Open Hydras 3.
- Select the work area in the tree diagram in which the Parsivel measuring station is to be created.
- Select the "File | Import measuring station configuration (XML)" menu. The "Open" window opens.
- Select the XML file that you exported in the previous steps from ASDO and confirm your selection with "OK". Parsivel is now a measuring station in Hydras 3 with corresponding sensors.

## 7 Updating Parsivel firmware

OTT Hydromet provides the latest update versions to OTT software on its internet site at [www.ott.com](http://www.ott.com) under the heading "Software updates". To update Parsivel firmware, proceed as follows:

- Download the update software for the Parsivel firmware from the OTT homepage into a directory on your computer. The update software for the Parsivel firmware includes two files with the names "`*DSP.bin`" and "`*IOP.bin`".
- Connect the Parsivel that you would like to update to your computer as described in the operating instructions "Present Weather Sensor Parsivel".
- Start the Parsivel ASDO software.
- Select the "Configuration" tab in the ASDO start window.
- In the "Interface" field, select the COM port of your PC to which the Parsivel is connected and the baud rate at which the transmission is configured.
- Click on the "Update" button. The "Open" window opens.
- From the file structure, select the directory to which you have saved the two Update files and mark the two files.
- Confirm the selection by clicking on the "Open" button. The Parsivel firmware is updated. When the update process is finished, the message "Firmware Update Successful" appears.
- Acknowledge the message by clicking on the "OK" button.

Document number  
56.551.003.B.E 02-0511

**OTT Hydromet GmbH**

Ludwigstrasse 16  
87437 Kempten · Germany  
Phone +49 831 5617-0  
Fax +49 831 5617-209

[info@ott.com](mailto:info@ott.com)  
[www.ott.com](http://www.ott.com)